



# **MEGAPULSE® II**

## **Shortwave Diathermy**

### **User Manual**

**Revised 03.27.2019**  
**Part No. 2903029M Rev 7**

This Manual contains confidential and proprietary information owned by Accelerated Care Plus ("ACP") which is protected by copyright. This Manual or any portion thereof may not be photocopied, reproduced or translated to another language without the express prior written consent of ACP. This Manual may only be used by entities who have purchased the equipment or have implemented the ACP program and are covered by an executed Lease Agreement with ACP containing a Confidentiality Agreement, which is incorporated by reference in its entirety. This Manual may not be used for any other purpose.

Any additional copies of the Manual shall be ordered from ACP. No changes or modifications shall be made to the Manual without prior review and written authorization from ACP. No authorization is given to market, sell, disclose, or exploit this Manual except as for purposes of using the Equipment as contemplated by the Lease Agreement.

ACCELERATED CARE PLUS MAKES NO WARRANTY OF ANY KIND WITH REGARD TO THIS MANUAL, INCLUDING, BUT NOT LIMITED TO, THE IMPLIED WARRANTIES OF MERCHANTABILITY AND FITNESS FOR A PARTICULAR PURPOSE. Accelerated Care Plus shall not be liable for errors contained herein or for incidental or consequential damages in connection with the furnishing, performance or use of this Manual.

The information contained in this document is subject to change without notice.















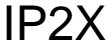

## **MEGAPULSE® II**

ACP manufactures a premier line of rehabilitation technologies to assist health care professionals with improved outcomes and quality-of-life for Patients. The ACP product line includes Pain Control Systems, Muscle Stimulators, Interferential Therapy, Therapeutic Ultrasound, Pulsed Shortwave Diathermy devices, and advanced Therapeutic Exercise Systems. Our **MEGAPULSE®**, **NEUROPROBE®**, **OMNISTIM®**, **OMNISOUND®**, **OMNICYCLE®**, **OMNIVR®**, and **SYNCHRONY™** represent the most recent worldwide advances available for therapeutic application of electromedical devices and other rehabilitation technology.

ACP is internationally recognized for its contribution to research in the development of medical applications for therapeutic rehabilitation. The Company sponsors and conducts research at leading health care institutions and major universities throughout the world. This new medical frontier holds great promise and opportunity, which will result in substantial advancements in the health care industry and for ACP.

## SYMBOLS ON THE PRODUCT

| Symbol  | Used for   | Symbol  | Used for  |
|---|--|---|---|
|    | Serial number  |    | Type BF medical device per:<br>IEC 60601  |
|    | Date of manufacture  |    | Manufacturer  |
|    | Caution, consult accompanying documents  |    | Caution, electrical precautions   |
|    | Remote Control connection  |    | CE mark of confidence compliant to MDD (93/42/EEC)                                  |
|  | Connection Electrode Cable   |  | Classification against intrusion of water, dust, accidental contact of a body part. |
|  | Proper disposal required. Do not dispose of with regular household waste. Follow state and/or local regulations. |  | Alternating current device.   |
|  | Observe the user manual  |  | Consult instructions for use  |
|  | Protect the product from humidity  |  | ON / OFF push button  |

## TABLE OF CONTENTS

|  |                              |
|--|------------------------------|
| <b>SYMBOLS ON THE PRODUCT</b> .....                            | <b>1</b>                     |
| <b>DIATHERMY INDICATIONS &amp; CONTRAINDICATIONS</b> .....     | <b>3</b>                     |
| Indications .....  | 3                            |
| Contraindications.....   | 4                            |
| <b>DIATHERMY WARNINGS &amp; PRECAUTIONS</b> .....              | <b>5</b>                     |
| Warnings .....   | 5                            |
| Precautions .....  | 7                            |
| <b>THE MEGAPULSE® II</b> .....                                 | <b>8</b>                     |
| Delivery of the Megapulse® II.....                             | 8                            |
| Introduction .....   | 8                            |
| Controls and Functions.....                                    | 9                            |
| <b>TREATMENT GUIDELINES</b> .....                              | <b>10</b>                    |
| Inductive Shortwave.....                                       | 10                           |
| Depth of Penetration.....                                      | 11                           |
| Thermal Dosage .....   | 11                           |
| <b>INFECTION CONTROL EQUIPMENT AND PRINCIPLES OF USE</b> ..... | <b>12</b>                    |
| Definitions .....  | 12                           |
| Universal Precautions - Body Substance Isolation .....         | 12                           |
| Cleaning / Disinfecting of the Megapulse® II .....             | 12                           |
| Cleaning and Low Level Disinfection.....                       | 12                           |
| Intermediate Level Disinfection .....                          | 13                           |
| Use of Barriers.....   | 13                           |
| <b>MODES OF OPERATION</b> .....                                | <b>14</b>                    |
| Thermal Effect Variables .....                                 | 14                           |
| Physiological Effects of High Frequency Currents .....         | 15                           |
| Dosage .....   | 15                           |
| Operating Instructions .....                                   | 16                           |
| Setup Procedure for Drum Inductive Applicator.....             | 17                           |
| Drum Inductive Applicator Removal .....                        | 18                           |
| Drum Inductive Applicator Reinstallation.....                  | 18                           |
| <b>TROUBLESHOOTING</b> .....                                   | <b>19</b>                    |
| Calibration .....  | 19                           |
| Service Center .....   | 19                           |
| <b>TECHNICAL SPECIFICATIONS</b> .....                          | <b>20</b>                    |
| Technical Data.....  | 20                           |
| Standards .....  | 20                           |
| Diagrammatic Representation of Pulse Trains .....              | 21                           |
| Megapulse® II Average Output Power .....                       | 22                           |
| <b>MEGAPULSE® II STANDARD AND OPTIONAL ACCESSORIES</b> .....   | <b>23</b>                    |
| Infection Control Supplies:.....                               | 23                           |
| <b>STANDARD LIMITED PRODUCT WARRANTY</b> .....                 | Error! Bookmark not defined. |

---

## DIATHERMY INDICATIONS & CONTRAINDICATIONS

**CAUTION:** Federal law restricts this device for sale or use by, or on the order of, a Practitioner licensed by the laws of the state in which he/she practices to use or order the use of the device.

Please notice that Accelerated Care Plus cannot provide medical advice. If you have specific medical questions, please contact your healthcare professional.

### Indications

Diathermy is used therapeutically to increase the temperature of tissues. It is generally accepted that heat produces the following desirable therapeutic effects:

- Relieves pain
- Increases the extensibility of collagen tissues
- Decreases joint stiffness
- Relieves muscle spasm
- Increases local blood flow

Megapulse Shortwave Diathermy system is indicated for use in the following conditions or applications:

- Disorders of the musculoskeletal system
  - Muscle spasm
  - Joint stiffness
  - Joint contractures
- Chronic inflammatory or infective conditions
  - Tenosynovitis
  - Bursitis
  - Synovitis
  - Chronic inflammatory pelvic diseases

## Contraindications

- Do not apply shortwave diathermy if the patient does not understand the potential risks.
- Do not apply shortwave diathermy if the patient is not able to cooperate with the operator in maintaining the proper position and in reporting the presence of a heating sensation which is the only indication of an adequate or excessive dose.
- Do not apply shortwave diathermy on pregnant patients.
- Do not apply thermal shortwave diathermy if there are open wounds, hemorrhage, ischemic tissue, tuberculous joints, or acute infections within the treatment area.
- Do not apply shortwave diathermy on patients who do not possess normal pain and thermal sensation in the area to be treated.
- Do not apply over or in close proximity to active cancer (except in terminal / palliative / hospice care), as therapy may increase blood flow to the tumor.
- Do not apply shortwave diathermy on patients, or within 10 feet of a person, with Cardiac Pacemakers or implanted defibrillators.
- Do not apply shortwave diathermy on patients, or within 10 feet of patients, who have **ANY** implanted systems with RF programming, or metallic lead, or any implanted system that may or may not contain a lead. Both the thermal and sub-thermal modes of operation pose a risk of tissue destruction.
  - If you are a physician who implants or monitors patients with leads or implanted systems with or without leads, explain to the patient what diathermy is, and stress that they should NOT receive shortwave or microwave diathermy therapy.
  - If you are a health care professional who uses diathermy (shortwave) in your practice:
    - Be sure to ask the patient about possible implants before deciding to administer shortwave or microwave diathermy therapy. If the patient has an implanted lead or an implant with or without a lead, diathermy should not be used even if the implant has been turned off. Examples of implanted systems that may or may not contain a lead include cardiac pacemakers and defibrillators, cochlear implants, bone growth stimulators, deep brain stimulators, spinal cord stimulators, other nerve stimulators, and infusion pumps.
    - Do not administer shortwave diathermy therapy to a patient who has had an implant in the past unless you are absolutely certain that the implant and all leads in their entirety have been removed.

**NOTE:** Leads are often left implanted after the implant is removed.

**NOTE:** *If there is a scar in or near the treatment area, check with the patient and/or the patient's chart to determine if there is metal under the scar.*

## DIATHERMY WARNINGS & PRECAUTIONS

**CAUTION: Federal law restricts this device for sale or use by, or on the order of, a Practitioner licensed by the laws of the state in which he/she practices to use or order the use of the device.**

**Please notice that Accelerated Care Plus cannot provide medical advice. If you have specific medical questions, please contact your healthcare professional.**

### Warnings

- Do not operate this device until the User Manual, including all Indications for Use, Contraindications, Warnings and Precautions, have been carefully read and understood.
- Operation of this device or placement of lead wires, probes, pads and electrodes in close proximity (less than 5 feet) to an operating shortwave or microwave diathermy unit may produce instability in the device output or burns at the treatment site.
- Treatment should not be applied over the carotid sinus nerves, (located in the anterior neck triangle), including, stellate ganglion, vagus nerve, or laryngeal or pharyngeal muscle. Particular care should be taken for patients with a known sensitivity to the carotid sinus reflex, as carotid sinus stimulation may alter blood pressure and cardiac contractility.
- Do not apply treatment over testes, heart or eyes. Electromagnetic effects may affect organ function.
- Treatment should not be applied when high fever is present, over swollen, severe infection, (osteomyelitis, sepsis, tuberculosis, etc.), or inflamed areas or skin eruptions, (e.g., phlebitis, thrombophlebitis, varicose veins, etc.).
- Do not apply over the lumbar or abdominal region, or over the uterus during menstruation as therapy may temporarily increase menstrual flow.
- Do not apply treatment over exposed spinal cord (i.e. following laminectomy, spinal fusion, etc.).
- Do not apply directly over the cranial region, as little is known about the electromagnetic effects on the cerebrum to determine if it represents a serious hazard when shortwave diathermy is applied to the head.
- Do not apply directly over the epiphysis of growing bones in children and adolescents because shortwave diathermy may enhance or inhibit bone growth.

**NOTE:** *The mean age for skeletal maturity in females is 15.5 years; in males, 17.5 years.*

- Do not apply treatment on a patient connected to patient monitoring devices, or within 5 feet of any active patient monitoring devices.
- Thermal Shortwave Diathermy should not be performed when metal is present in tissues in the treatment field. This includes Total Knee Arthroplasty, Total Hip Arthroplasty, other joint replacements, screws, wires, shrapnel, some stents, etc. Shunts may contain a valve rather than a pump. Good clinical practice with either sub thermal or thermal Short Wave Diathermy (SWD) is to remove all external metal from the treatment field such as buttons, snaps, under-wire bra, belt buckle, metal zippers on clothing or pillowcase covers, intra-uterine device, shrapnel, body piercing, jewelry.
- Do not apply directly over or in close proximity to Deep Vein Thrombosis (DVT). Thermal agents should be avoided in early phases of a DVT. Therapists should follow the guidelines provided by the referring physician on recommended activity level and modality use.
- Do not apply shortwave diathermy through synthetic blend clothing. Certain plastics and synthetics (e.g., nylon, polyvinyl chloride, and polyethylene terephthalate), which are usually regarded as good insulators, can also be heated significantly by shortwave diathermy units. Some fabric blends that contain synthetics can also be heated. Additionally, synthetics can trap moisture near the body, which can rapidly heat and burn a patient.
- Always keep cables spaced apart. Route cables as designed for the unit, using all spacing insulators and cable supports provided. Do not put anything else between the cables and never cross cables.

- Keep cables at least several inches away from any objects or material, especially metal or grounded objects.
- Do not lean on or hold the cables while the generator is activated. In addition to the strong heating effect, a deteriorated cable could break down and expose the user to high voltages.
- Keep all line cords away from the diathermy unit cables. Do not store or coil line cords where they can come close to the cables on an operating diathermy unit.
- Before increasing generator output in response to a report of inadequate patient heating, verify that cables are properly routed, evenly spaced, and away from any metal or grounded objects. The heating effect may be "stolen" from the patient at a spot where the cables are close to a metal object or each other. Increasing the generator output under these circumstances will cause increased heating at that spot.
- Use a nonconductive treatment table and a mattress or couch without metal parts (e.g., decorative buttons, springs) near the patient, applicators, or cables. Do not use conductive mattresses or mattress covers.
- During application of shortwave diathermy, the operator and any other patients should stand at least 2 feet from the device.
- Do not apply shortwave diathermy over areas with excess adipose tissue.
- All equipment and accessories should be kept out of the reach of children or unqualified persons.
- Do not apply over areas of hemorrhage or active bleeding.
- Avoid applying to the body if wet. Dry the area thoroughly, as water in the treatment field may lead to uneven heating.
- All hearing aids should be removed during shortwave diathermy treatment.
- Do not turn on the output of the Megapulse® II until the head (Drum) is properly placed above/over the treatment area.
- Caution should be used when applying thermal shortwave over areas of body which lack normal sensation. Absent or diminished sensation should be avoided or, if unavoidable, treated with caution. Establishment of acceptable intensity levels for desensitized areas may be related to the intensity levels tolerated on normal skin in opposite or related body parts.



## Precautions

- Application site and settings should be based on the guidance of the prescribing practitioner.
- Do not connect this device to any wall outlet that has not been properly grounded, or to any electrically non-isolated medical device.
- Use only ACP specified accessories and/or supplies with ACP devices. Do not use any power cords, or power supplies, other than the ones provided or specified for this device. Use of any other power supply could seriously damage the device and will void the warranty.
- When cleaning the device, never immerse them or wash them with water. See the infection control section in this manual for cleaning instructions. Devices should not be submerged in water or other liquids.
- Failure to follow the manufacturer's prescribed maintenance for this device may lead to device failure and transient or unreliable performance. State and federal survey and JCAHO (Joint Commission on Accreditation of Healthcare Organizations) require all equipment to be maintained and calibrated according to the manufacturer recommended schedules.
- A potential electric shock hazard exists once the device outer casing has been in part, or fully, removed. Only qualified service personnel should perform service and repairs. Warranty will be voided if the outer casing has been removed or tampered with.
- Inspect and cleanse the skin prior to application. Following treatment, check the skin for evidence of irritation or burns, and if present, treat as appropriate. If the patient has, or complains of, skin irritation following treatment; shorten the treatment time on the next treatment session or use an alternative type of therapy or drum inductive applicator placement.
- The treatment area should be checked from time to time, and if there is evidence of, or if the patient complains of, pain or overheating during treatment, adjust the output downward until it is tolerated by the patient. If the patient continues to complain of pain or overheating, discontinue the treatment and shorten the treatment time on the next treatment session, or use an alternative type of therapy or drum inductive applicator placement.
- Do not apply treatment directly over/under hot or cold packs due to possible activation of chemical packs with diathermy treatment. Caution is recommended when treatment follows the application of hot or cold therapy, which may alter the patient's sensation. Application of thermal agents over areas of impaired circulation should be performed with caution as the circulation may be insufficient to heat or cool the tissue, altering the patient's perception of warmth and pain. Burns or tissue necrosis may result from subsequent treatment.
- Treatment should not follow the application of medicated patches, salves, or creams. The presence of RF energy may be altered by the presence of these materials on the patient's skin. Some medications can alter the patient's sensation. Heat can also increase the absorption of medication and may be contraindicated. If there is a medical necessity to perform such treatments, these patients should be monitored diligently during application.
- Caution should be used in the presence of recent surgical procedures, fractures or healing bone and soft tissue when therapy may disrupt the healing process. Thermal shortwave diathermy should be applied with caution over bone where minimal or no soft tissue is present.
- Caution should be taken with patient exhibiting psychological or physical hypersensitivity to the therapeutic treatment. Several attempts should be made to place them at ease so that their confidence and cooperation can be gained during the treatment.
- If the device operator is pregnant, she should remain at least 5 meters away from the applicator when the unit is turned on.

## THE MEGAPULSE® II

### Delivery of the Megapulse® II

Upon receipt of the unit check for any damage which may have occurred in transit. If any signs of damage are found then retain all packing material and inform the carrier and the Company or its agent from whom the unit was purchased.

Check that the AC voltage and frequency stamped on the rear panel of the unit are as required. If the AC supply is not within the range specified on the rear panel, **DO NOT CONNECT THE UNIT TO YOUR AC SUPPLY.**

The AC supply must be capable of providing .75A (220-240V 50/60Hz) or 1.5A (100-120V 50/60Hz). Connect the AC plug to a suitable socket. The Megapulse® is now ready for use.

### Introduction

In 1890, Darsenval first applied high frequency currents therapeutically. In the early 1920's investigators began experimenting with shortwave therapy devices of various configurations for a variety of purposes. After World War II, microwave therapy was introduced following the development of radar. Both shortwave and microwave therapy are now in use on a routine basis in physical medicine.

Although, the specific mechanisms behind the use of high frequency currents are not altogether understood, it is well established that this energy causes vibration of ions and molecules within the cells and tissues. Depending on the intensity of the high frequency energy applied, this vibrating effect causes more or less tissue heating. Significant stimulatory effects may occur in the tissue at thermal and subthermal levels of high frequency energy exposure. When the frequency used is high, e.g.: 27,000,000 Hz (27 MHz) as applied in shortwave equipment, the energy may be directed to the body without direct electrical contact of the electrodes.

High frequency energy used in therapy when absorbed by the body produces thermal effects by inducing a current into the tissue which increases tissue kinetic energy through resistive heating. Temperature increases occur when energy is expended in the tissue faster than it can be removed by the circulatory system or by conduction into adjacent tissues. Temperature is therefore a yardstick of net energy absorption in the tissue.

Energy absorption in tissue is the underlying factor which must control dosage. Shortwave should not be used merely to maximally increase temperature in the tissue undergoing treatment. Dosage needs to be applied based on the nature and location of injury and whether acute or chronic in nature. It is well recognized that lower dose applications are generally used in acute conditions and higher dose applications are used in more chronic conditions.

## Controls and Functions

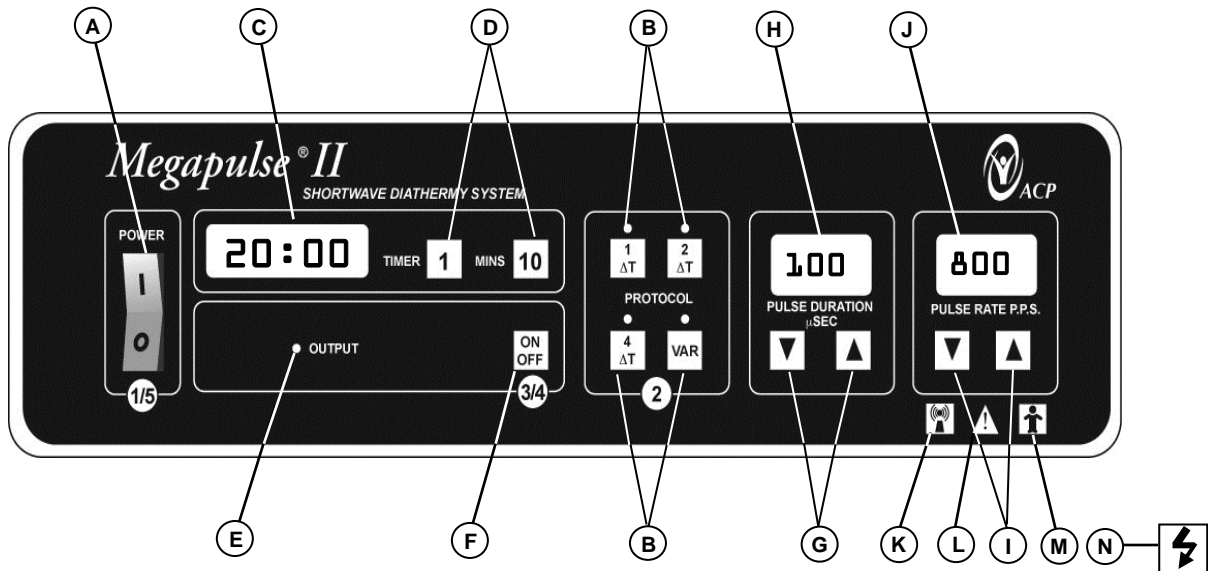

**FIGURE 1 – Megapulse® II - Front Panel**

The letter associated with each control or indicator in this section corresponds to the labeling in FIGURE 1.

- A. Power AC on/off switch. (1/5) Two position rocker, up for ON, down for OFF. The switch is illuminated when the power is ON.
- B. Membrane push button mode switches to select various thermal modes. (2) The mode can only be changed when output is off. The selected mode is indicated by the illuminated LED.
- C. Timer display, indicates the TREATMENT TIME selected, or with the treatment activated, the TREATMENT TIME remaining.
- D. Timer selector switches, used to select the TREATMENT TIME. Maximum time selectable is 30 minutes.
- E. Output Display LED indicators to show that the output is ON or OFF.
- F. Output switch, changes the output ON and OFF (3/4) as indicated by the output display LED.
- G. Pulse duration switches, select the pulse duration in microseconds as displayed in the PULSE DURATION display. Pressing the “Up Arrow” increases the pulse duration to the next higher setting, pressing the “Down Arrow” reduces it to the next lower setting. Does not function if 1ΔT, 2ΔT, 4ΔT is selected.
- H. Pulse duration display indicates the PULSE DURATION in microseconds (μsec).
- I. Pulse rate switches select the number of pulses per second as displayed in the PULSE RATE display. Pressing the “Up Arrow” increases the number of pulses per second to the next higher setting, pressing the “Down Arrow” reduces it to the next lower setting. If 1ΔT, 2ΔT, 4ΔT is selected, this function is disabled.
- J. Pulse rate display indicates the number of pulses per second (PPS).
- K. Symbol IEC 878-03-04 Non-ionizing radiation.
- L. Symbol IEC 348 Attention, Consult Service.
- M. Symbol IEC 878-02-03 Indicates Type BF Equipment.
- N. Symbol IEC 878-03-01 Indicates that high voltage is generated within the drum inductive applicator.

## TREATMENT GUIDELINES

### Inductive Shortwave

A coiled conductor is placed in the drum inductive applicator which is usually in the shape of a drum. The current flowing through the coils produces a magnetic field at right angles to the alignment of the coils. The magnetic field induces more current into the muscle and less in the subcutaneous fat than the capacitive technique. Today the drum monode electrode is the most commonly used pulsed shortwave electrode. Drum inductive applicators are generally referred to as monodes. Drum inductive applicators are operated in the pulsed mode to avoid overheating of the coils.

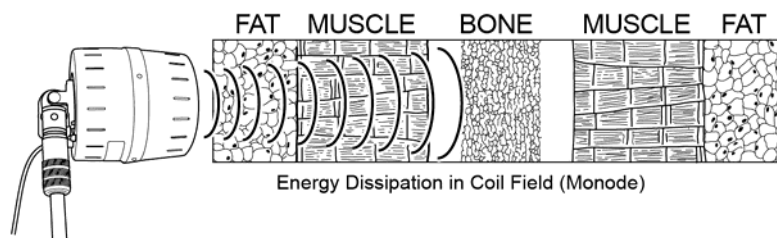
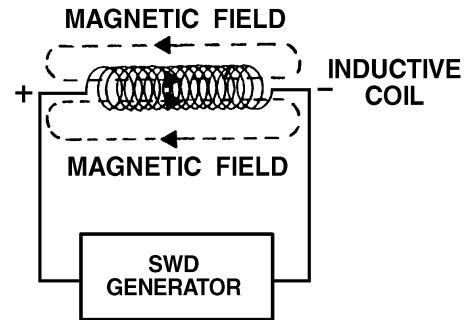

Historically, inductive electrodes were manually coiled or circumferentially wound around the area of the body to be treated.

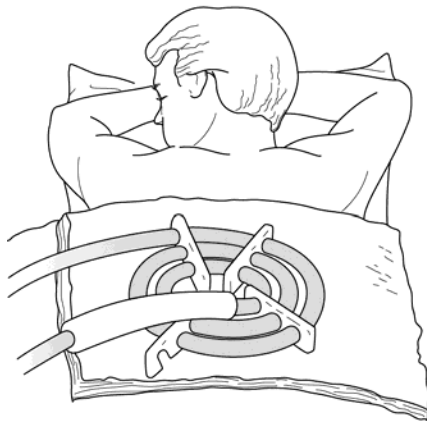

**PANCAKE COIL**

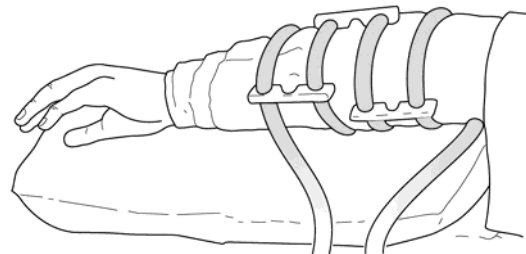

**CIRCUMFERENTIAL COIL**

Modern drum inductive applicators are heavily shielded to prevent unwanted emissions and their corresponding interference with the operation of computers, telephones and other electrotherapy equipment used in the clinic. The new systems also provide adequate RF shielding to protect the operator and other medical equipment from stray radiation fields.

**NEWER SHIELDED  
DRUM INDUCTIVE APPLICATOR**

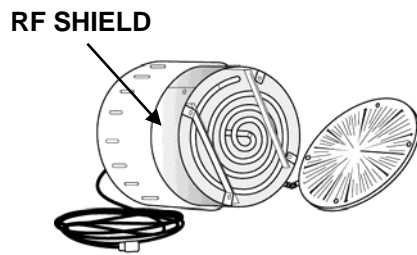

**EACH FLAP  
CONTAINS COIL**



**OLDER UNSHIELDED  
INDUCTIVE APPLICATOR**

**Depth of Penetration**

Pulsed shortwave with magnetic field monode drum inductive applicators should be used to treat deeper tissue. Penetration depth for fat at 27 MHz is approximately 62.6 inches (159cm) whereas depth for muscle is 5.5 inches (14cm). This is somewhat modified by the SAR (Specific Absorption Rate) of the applicator and the method of application.

For inductive field applicators, if the drum inductive applicator is in direct contact with the skin (with a towel layer in between), the primary effects will be in a field formed from the surface to a depth of 2 inches (5cm).

**Thermal Dosage**

Pulsed shortwave diathermy provides outputs capable of producing thermal effects. Average power output in watts is controlled by the peak power and the duty factor. The duty factor is controlled by the pulse duration and the pulse rate. The higher the average output, the greater the thermal effects in the tissue.

**AVERAGE POWER (WATTS) = PEAK POWER (WATTS) x DUTY FACTOR**

**DUTY FACTOR = PULSE RATE (PPS) x PULSE DURATION (µsec)**

**48W = 150 W x 800 PPS x 400 µsec**

**PSWD DOSE WITH MEGAPULSE® CHART FOR A 20 MINUTE TREATMENT:**

| PULSE DURATION | AVERAGE POWER IN WATTS (W) |        |        |        |        |        | EFFECT     |
|----------------|----------------------------|--------|--------|--------|--------|--------|------------|
|                | 3.0W                       | 6.0W   | 12.0W  | 24.0W  | 36.0W  | 48.0W  |            |
| 400 µSec       | 3.0W                       | 6.0W   | 12.0W  | 24.0W  | 36.0W  | 48.0W  | 4°C        |
| 200 µSec       | 1.5W                       | 3.0W   | 6.0W   | 12.0W  | 18.0W  | 24.0W  | 2°C        |
| 100 µSec       | .75W                       | 1.5W   | 3.0W   | 6.0W   | 9.0W   | 12.0W  | 1°C        |
| 65 µSec        | .49W                       | 1.0W   | 2.0W   | 3.9W   | 5.9W   | 7.8W   | SUBTHERMAL |
| 40 µSec        | .30W                       | .6W    | 1.2W   | 2.4W   | 3.6W   | 4.8W   |            |
| 20 µSec        | .15W                       | .30W   | .60W   | 1.2W   | 1.8W   | 2.4W   |            |
| PULSE RATE     | 50 PPS                     | 100PPS | 200PPS | 400PPS | 600PPS | 800PPS |            |

## INFECTION CONTROL EQUIPMENT AND PRINCIPLES OF USE

### Definitions

- **Barrier Film** – One-time use, disposable plastic film for use over touch/operator surfaces of equipment to reduce risks of cross-contamination and need for high level disinfection of equipment between patients.
- **Germicidal Disposable Wipe** – Low level and/or intermediate level disinfectant germicidal disposable wipe for use on electrotherapeutic devices and accessories.
- **Plastic Wire Sleeve** – Barrier to be used on applicator wire, covering the junction of the drum inductive applicator and generator unit.
- **Drum Inductive Applicator Cover** - Barrier to be used between the drum inductive applicator and skin.

### Universal Precautions - Body Substance Isolation

Universal Precautions (UP) must be implemented in the care of all patients to protect employees from occupational exposure to blood borne pathogens. Personal protective equipment (gloves, masks, gowns) should be available and worn by staff when occupational exposure to blood, body fluids containing blood, semen and vaginal secretions is likely to occur. Health care workers with exudating lesions or weeping dermatitis should refrain from all direct patient care and from handling patient care equipment until the condition resolves. Equipment must be cleaned/disinfected and protective barriers used when appropriate.

### Cleaning / Disinfecting of the Megapulse® II

Modality equipment shall be cleaned / disinfected per facility infection control policy. ACP recommends the following guidelines:

Proper cleaning procedures at the end of each treatment and/or at the end of each day are recommended.

Before cleaning the Megapulse®, make certain that the machine is OFF and that the plug has been removed from the wall socket. Periodically clean the outer case, drum inductive applicator and cables with ACP approved infection control products. Use of other cleaning solutions or disinfectants may damage the finish of the outer case. Care must be taken to avoid getting excess moisture into the unit. **NEVER IMMERSER THE MEGAPULSE® IN ANY LIQUID OR CLEANING SOLUTION.**

The drum inductive applicator cables and connectors should be inspected periodically for signs of damage, especially cable insulation.

### Cleaning and Low Level Disinfection

***This is a recommended daily housekeeping practice to keep the equipment clean and free of contaminants which could contribute to transmission of infection. The following practices are recommended for use when treating intact skin without the presence of physiologic fluids such as blood and urine.***

- Clean equipment daily with ACP germicidal wipes. At the end of the day, wipe common contact surfaces, such as control panel and diathermy arm and head, with germicidal disposable wipe and allow to air dry. This technique will inactivate *M. tuberculosis* as well as most bacteria and viruses. This will also facilitate removal of organic material contaminants from equipment.
- Clean diathermy head with ACP germicidal wipes after each patient use.

## Intermediate Level Disinfection

This method is recommended to keep the equipment clean and free of contaminants when used between patients for treatment of non-intact skin or incontinence management, where there is an increased risk of patient cross-contamination.

- After each use, clean common contact surfaces, such as control panel and diathermy arm and head, with ACP germicidal wipes.
- With a second ACP germicidal cloth, wipe again leaving surfaces wet for at least 5 minutes. Allow the surface to air dry before patient use.
- Barriers should also be used on the equipment for treatment of non-intact skin or incontinence management. This technique will inactivate *M. tuberculosis* as well as most bacteria and viruses.

## Use of Barriers

The use of an all-purpose barrier film that provides surface protection from cross-contamination from a variety of applications should be used whenever dealing with non-intact skin or the chance of coming in contact with bodily fluids. Barrier film is designed to cover any surface that may be touched during a patient treatment to help prevent cross-contamination. Barrier film is for single-use only. The film is discarded after each patient treatment. The procedure for use is as follows:

1. Wash hands.
2. Apply intermediate level disinfection prior to barrier application.
3. Select, tear and place barrier film over the operatory surfaces of the Megapulse® unit.
4. Select, tear and place barrier film over adjustment points of the drum inductive applicator arm, such that if the position of drum inductive applicator needs to be adjusted during treatment parts of the drum inductive applicator arm that may be touched are covered.
5. Apply plastic cover over drum inductive applicator.
6. Prepare any items which may come in contact with the therapist during treatment, such as pens, assessment tools, cart handles, etc.
7. Don gloves.
8. Perform shortwave treatment.
9. After treatment, wash hands, don new gloves and remove plastic barrier film from Megapulse® unit and discard.
10. Carefully remove plastic drum inductive applicator cover in an inside-out manner, ensuring the outside of the plastic cover does not come in contact with the drum inductive applicator. Discard.
11. Use intermediate level disinfection prior to the treatment of the next patient.



## MODES OF OPERATION

### Thermal Effect Variables

#### I. Tissue Energy Dissipation

The extent of the thermal effect in tissue is based on the tissue energy dissipation. The time average value of the locally dissipated energy is given by the formula:

$$P = 0.5 \sigma E^2 \text{ (W/m}^3\text{)}$$

$\sigma$  = specific electrical conductivity of the tissue  
**E** = amplitude of the local electric field strength

At a frequency of 27 MHz, muscle has a resistance of 0.6 ohms / meter (10 times lower than fat) due to its high electrolyte content . . . thus energy will be dissipated more rapidly in muscle tissue. The energy dissipation is often expressed in W/kg, by standardization of the specific mass density  $\rho$ . The Specific Absorption Rate (SAR) is defined as follows:

$$\text{SAR} = 0.5 \sigma E^2 / \rho \text{ (W/kg)}$$

For muscle tissue  $\rho = 1070 \text{ kg/m}^3$

For Fat  $\rho = 940 \text{ kg/m}^3$

#### II. Drum Inductive Applicator Design and Application Technique

The SAR is also controlled by the shape of the magnetic field, the drum inductive applicator design and the positioning on the patient. Research by Lehman (Heating patterns produced by shortwave diathermy applicators, Archives of Physical Med Rehabil 64:575 - 577, 1983) demonstrates a typical SAR of 0.39 to 2.67 for inductive field applicators. Typical values for the Megapulse® II drum inductive applicator is 1.5 SAR. The higher the SAR value, the greater the thermal effect in the tissue.

#### III. Treatment Time

In general treatment times for pulsed shortwave is 20 minutes. The dosage charts have been computed based on a 20 minute application time. The sensation of mild, moderate or vigorous warmth by the patient should be the final indicator of obtaining the desired temperature in tissue. Start with the lowest dose capable of providing the desired sensation of temperature to the patient. Increase the pulse rate and pulse duration to increase the dose as clinically appropriate (assuming the patient has normal sensation). Preprogrammed doses may be selected on the front panel for ease of operator selection.

#### IV. Safety

Due to the design of the drum inductive applicator, a strong magnetic field is produced with only a small incidental amount of electrical field. As the distance away from the drum inductive applicator increases, the amount of energy in the magnetic field drops rapidly and becomes equal to the energy in the electrical field. The nominal distance where this occurs is called the boundary between near and far fields. This distance has been measured to be approximately 5 feet. However, both the magnetic and electrical field intensities are well below all applicable RF exposure standards at a distance of 2 feet from the drum inductive applicator.



## Physiological Effects of High Frequency Currents

Landis Et Al, demonstrated that capillary pressure is raised considerably by elevation of tissue temperature. Lewis and coworkers demonstrated increased histamine release and capillary dilation following shortwave application. Bierman, in discussing pain relief following shortwave, discusses increased circulatory response with respect to removal of chemicals, such as bradykinins and lactic acids, which are known to lower the firing thresholds of pain transmitting fibers. It is possible that this increased vascular flow may reduce these initiators sufficiently in the local area to decrease receptor binding activity and thus decrease nociceptor firing rate thus pain sensation. Heat reduces muscle spindle firing rates and stretch receptor sensitivity thus reducing muscle spasm (hypertonicity).

It is well known that temperature increases of as little as one degree Celsius may affect cellular oxidation and thus increase cellular metabolic rates. This effect may contribute to acceleration of cellular repair processes and metabolism.

Cholnoky discusses the dilating effect on the venous and arterial capillary system of shortwave therapy. He feels that reabsorption of cellular exudates and toxins is accelerated with application of high frequency currents due to increased venous and lymphatic circulation. Excessive fluid buildup in the area is also reduced by venous drainage. Increased capillary pressure and vasodilatation will also renew and assist in reestablishing blood supply to the inflamed areas. This effect should assist in the establishment of normal metabolism. Moderate to vigorous heat can heat collagen to its viscoelastic point (above 40-41°C) allowing residual elongation following stretch or mobilization, making PSWD an effective modality for treatment of scar tissue and contracture.

### Summary of Physiologic Effects

1. Vasodilatation of blood vessels.
2. Increase in cellular kinetic energy.
3. Increase in arterial, venous and lymphatic circulation.
4. Increase in reabsorption of exudates and toxins.
5. Decreased pain due to drop in local supply of kinins, prostaglandins and lactic acid based on improved drainage.
6. Increased cellular metabolic rate.
7. Reduction of muscle spasm.
8. Heating of connective tissue to viscoelastic point for "heat-and-stretch".

## Dosage

Proper dosage is most important for effective application of therapy. Dosage levels on the Megapulse® are established based on the pulse duration and pulse rate, i.e.: the greater the rate and duration, the more energy produced and the greater the thermal effect. The output peak power is fixed at 150 watts. Schliephake and Lehman developed the following dosage pattern:

**Dose - Variable (VAR):** Barely detectable warmth set for low pulse duration [65 µsec] and rate [100-400 pps], acute inflammatory conditions, and pain.

**Dose 1 - 1ΔT:** Mild warmth (pulse duration [100 µsec] and rate [800 pps] sub-acute inflammatory process).

**Dose 2 - 2ΔT:** Moderate warmth (pain syndromes, muscle spasm and chronic inflammation, increased blood flow pulse duration [200 µsec] and rate [800 pps]), stretch collagen tissue in patients with reduced muscle mass, stretch collagenous tissue in patients with reduced muscle mass and circulation.

**Dose 4 - 4ΔT:** Vigorous heating (stretch collagenous tissue pulse duration [400 µsec] and rate [800 pps]).

### Treatment Time

Generally treatment beyond 30 minutes is not recommended. General rule: Acute and inflammatory process 15-30 minutes, 1ΔT, 2ΔT, 4ΔT: 20 minutes treatment time. Always start with a low dose, and increase to a higher dose if needed, following patient response to treatment. Always start with a low dose and move to a higher dose if needed following the patient response and sensation (use sub-thermal treatment for patients with reduced or absent sensation).

## Operating Instructions

Numbers in brackets in the following operating instructions refer to the front panel drawing FIGURE below.

1. Connect the Megapulse® II to a suitable AC outlet, and energize the unit by pressing the Power Switch (1) up. The Power Switch will light up, the buzzer will sound briefly and the Timer Display (2) will show -65-. The microprocessor in the unit now completes a short self-test routine.
2. After 4 seconds the Timer Display (2) will change to 20:00. The 1 $\Delta$ T MODE (3) indicator LED will light, the PULSE DURATION DISPLAY (4) will indicate 100  $\mu$ s and the PULSE RATE DISPLAY (5) will show 800 PPS. If the OUTPUT ON/OFF CONTROL (6) switch is pressed with no time set on the display, the buzzer will sound and the output will not be energized.
3. Audible confirmation of the operation of the front panel push switches may be enabled by turning the unit on while holding down the VAR Mode switch (3). The display will read "set up" then "beep on" or "beep off". Use the PULSE DURATION  $\nabla$ (7) key to turn the beep to "on" or "off". Press a timer key (8) to exit setup and save the settings.
4. Set the required treatment time by pressing the timer switches (8). The maximum treatment time allowed is 30 minutes. This can only be adjusted if the variable (VAR) MODE has been selected.
5. The connecting cables associated with the drum inductive applicators should be positioned in such a way that contact with a patient, or conductive or energy absorbing object, is avoided.

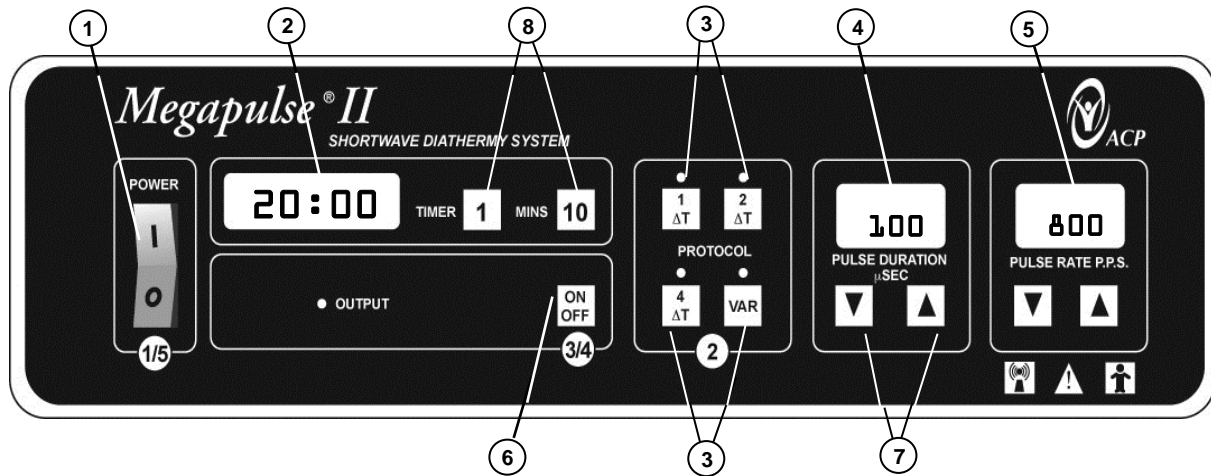

## Setup Procedure for Drum Inductive Applicator

1. The drum inductive applicator may have an amber indicator light which indicates when the treatment is on (provided a mode that supplies enough power to drive the indicator is selected). The amber light is present on older units, and was deleted in latter production units.
2. Select the output MODE using the switches (3) marked 1 $\Delta$ T, 2 $\Delta$ T, 4 $\Delta$ T or VAR based on the desired application. The green indicator LED above each switch shows the current selection. The power output cannot be switched on when the HIGH Q Drum Inductive Applicator is disconnected.
3. In variable MODE (VAR), select the required PULSE DURATION using the Up and Down Arrow switches (7). The desired selection will be displayed in the PULSE DURATION DISPLAY (8).
4. Adjust the position of the drum inductive applicator by slackening the arm hand wheels. Position the drum inductive applicator in direct contact with the treatment site with a terry cloth towel between the drum inductive applicator and the skin. As an alternative the drum inductive applicator may be placed 1/2" above the surface to be treated without direct contact.
5. When the drum inductive applicator has been placed in position tighten the hand wheels on the arm to prevent movement. Switch treatment ON (6). The protocol LED (3) on the front panel will light.
6. If at any time during treatment the output is returned to the OFF position (6), the timer (2) will stop and then restart when the output control is turned on again.
7. At the end of the treatment time, when the Timer Display (2) reaches 00:00, the buzzer will sound and the shortwave output power will turn off.
8. As the Megapulse® II is microprocessor controlled, it continually "self checks". If an error in function of the microprocessor is detected the shortwave power will be immediately turned off and the word FAIL will be shown on the Timer Display (2) for approximately 2 seconds. After this the microprocessor will attempt to restart as from power up. If the unit repeatedly fails, then qualified service personnel must be called.
9. The unit incorporates a safety mechanism in case of overheating. If the unit overheats the treatment is automatically switched OFF, the buzzer sounds intermittently, and "Hot" is shown on the timer display (2).
10. Testing the output (if output tester is available) - Select the 4 $\Delta$ T mode (3). Turn the treatment on (6). Place the output tester flat against the center of the application head. The light on the output tester should turn on. If it does not, then qualified service personnel must be called.

## Drum Inductive Applicator Removal

It may be necessary to remove the Drum Applicator from the articulating arm to apply to a patient lying in a bed. To remove the Drum Applicator, first loosen the locking collar turning counter-clockwise until you can see the white nylon washer as shown.

**Locked**

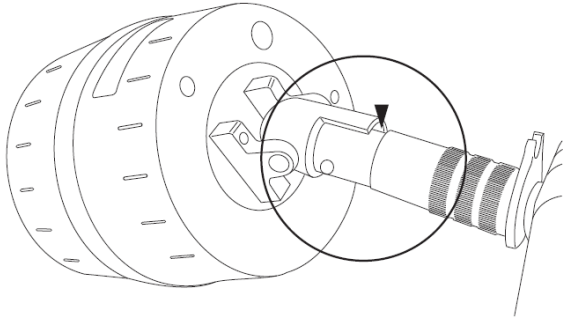

**Unlocked**

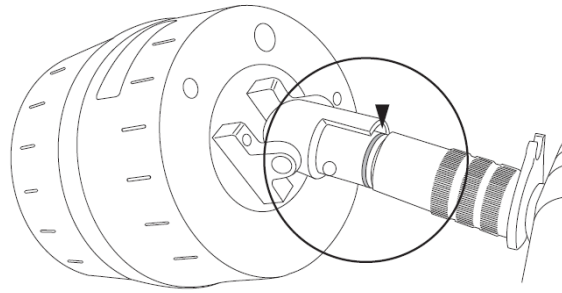

Next press gently on the drum applicator pin to dislodge the drum applicator from the articulating arm. The drum applicator can now be applied to a patient where the articulating arm might have obstructed the therapy.

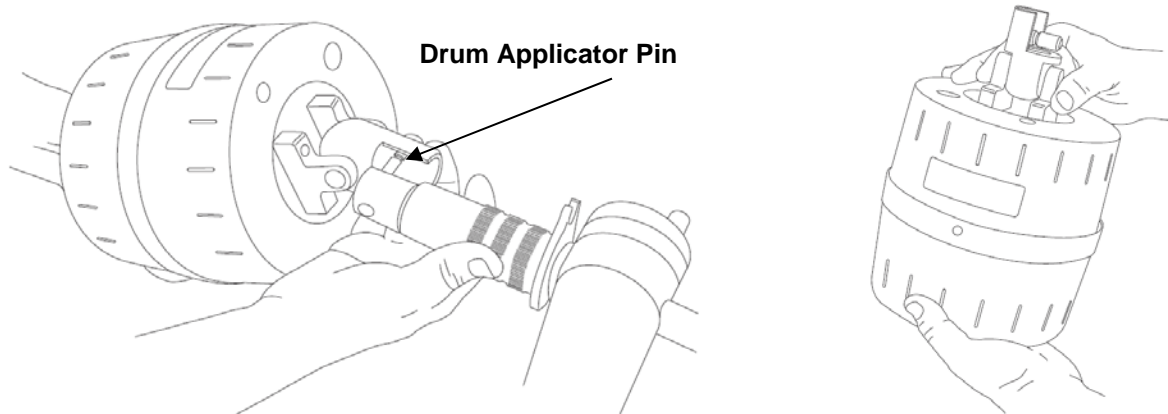

## Drum Inductive Applicator Reinstallation

To reinstall the drum applicator, reverse the above process. Be sure the pin is properly seated and the locking collar has been properly adjusted clockwise such that the white nylon washer is compressed and no longer visible at the notch indicated below. Verify that the drum applicator is secure prior to continued patient use.

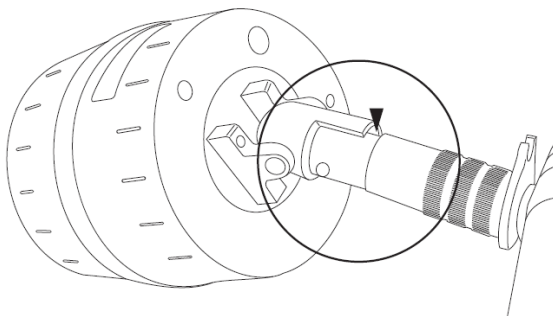

## TROUBLESHOOTING

The following table lists Megapulse® problem symptoms and possible areas to check for the problem causes. If these suggested measures do not correct the machine malfunction, call your ACP Customer Support representative.

| PROBLEM   | CAUSE  | REMEDY  |
|---|--|---|
| Unit will not power on  | <ul style="list-style-type: none"> <li>Power Cord not plugged into the unit or AC outlet</li> </ul>  | <ul style="list-style-type: none"> <li>Verify the electrical cord has a molded <b>HOSPITAL GRADE</b> plug (see below)</li> <li>Verify if power cord is connected as appropriate and check that the cord is not frayed/damaged</li> <li>Verify AC outlet is functional</li> </ul>  |
| APPL message is displayed on the unit                               | <ul style="list-style-type: none"> <li>The drum inductive applicator is not connected to the generator unit.</li> </ul>  | <ul style="list-style-type: none"> <li>Verify that the drum inductive applicator connector is plugged into the back of the main unit. Check that the connectors are plugged-in properly.</li> <li>If the connector is plugged in properly, and upon turning off the unit and re-starting, the same message is displayed, please contact the Service Center.</li> </ul>  |
| FAIL message is displayed on the unit                               | <ul style="list-style-type: none"> <li>There is an internal failure in the unit</li> </ul>   | <ul style="list-style-type: none"> <li>Contact the Service Center</li> </ul>  |
| HOT message is displayed on the unit.                               | <ul style="list-style-type: none"> <li>The output power may be out of appropriate calibration range</li> </ul>   | <ul style="list-style-type: none"> <li>Contact the Service Center</li> </ul>  |
| Treatment will not start  | <ul style="list-style-type: none"> <li>No program selected</li> </ul>  | <ul style="list-style-type: none"> <li>Select desired treatment program and press START</li> </ul>  |
| Patient cannot detect output, when unit is ON and treatment running | <ul style="list-style-type: none"> <li>drum inductive applicator is not emitting output</li> <li>Patient has impaired sensation over treatment area</li> </ul> | <ul style="list-style-type: none"> <li>Use output tester (if available) to determine if unit has failed or is operating incorrectly.</li> <li>If LED does not illuminate properly, contact ACP at (800) 350-1100 about replacing the unit</li> <li>If LED is illuminated, discontinue treatment and test patient for impaired sensation over treatment area.</li> </ul> |

Identify the "HOSPITAL GRADE" marking on the power plug

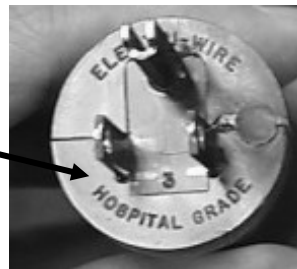

### Calibration

If clinicians are to give prescribed therapeutic doses of shortwave with reasonable accuracy, the machine used is required to meet the equipment performance standard (21 CFR 890.5290) instituted by the Food and Drug Administration. Periodic calibration of treatment parameters having a direct influence on the physiological effect of shortwave on tissue, i.e., power output, and time accuracy, is a major part of this regulation. It is suggested, therefore, that the Megapulse® be verified at least once yearly. It is recommended that recalibration be performed by qualified service personnel.

Due to the sophisticated nature of the Megapulse®, ACP requires that all service work be performed at its manufacturing or service facility or by a qualified ACP field technician or ACP authorized service facility.

### Service Center

For repair or service of ACP products and accessories, please call (800) 350-1100 and follow the prompts. Normal hours of operation are 6:00am to 5:00pm Pacific Standard Time. After hours, please leave a message and a technician will return your call during the next scheduled workday.

## TECHNICAL SPECIFICATIONS

### Technical Data

| GENERAL:                   |  |
|----------------------------|--|
| Power Supply:              | 240, 120 ac 50/60Hz.   |
| Power consumption:         | 180W max.  |
| Fuses:                     | Externally Replaceable<br>2 x T 2A 20mm for 120  |
| Size:                      | Approx. H: 870 mm (34.25 in) / D: 410 mm (16 in) / W: 410 mm (16 in)   |
| Weight:                    | 39 kg (86 lbs)   |
| Classification:            | Class 1: Type BF. (IEC 60601-1: 2001)  |
| Frequency:                 | 27.12 MHz $\pm$ 20 KHz   |
| Output Power:              | 150W peak power ( $\pm$ 20%) into 50 Ohm load pulsed mode  |
| Output modes:              | Pulsed output waveforms are available as selected by the front panel. In pulsed mode the output is square wave modulated.  |
| Pulse modes presets:       | <b>Protocol 1<math>\Delta</math>T</b> - Timer is preset to 20 minutes, pulse rate is set 1 $\Delta$ T to 800 PPS and pulse duration to 100 $\mu$ Sec.<br><b>Protocol 2<math>\Delta</math>T</b> - Timer is preset to 20 minutes, pulse rate is set 2 $\Delta$ T to 800 PPS and pulse duration to 200 $\mu$ Sec.<br><b>Protocol 4<math>\Delta</math>T</b> - Timer is preset to 20 minutes, pulse rate is set 4 $\Delta$ T to 800 PPS and pulse duration to 400 $\mu$ Sec.<br><b>VAR</b> - Timer is variable from 0 - 30 minutes, but Variable preset at 30 minutes, pulse rate is set to 400PPS, 65 $\mu$ Sec pulse duration. Pulse rate, timer and pulse duration are variable over their full range in this mode.<br><b>NOTE:</b> <i>On Megapulse® units manufactured prior to May of 2004, the default pulse rate setting is 100 PPS.</i> |
| Pulse Duration:            | 400, 200, 100, 65, 40, 20 $\mu$ s available  |
| Pulse Repetition Rate:     | 50, 100, 200, 400, 600, 800 PPS available  |
| Timer:                     | The digital treatment timer indicates the set time in minutes and seconds prior to the start of treatment and treatment time remaining during treatment. The maximum setting of the timer is 30 minutes. The timer increments in 1 or 10 minute units.   |
| Timer accuracy:            | +/- 1 second at all settings   |
| Electrode:                 | Hi Q drum inductive applicator   |
| Cooling:                   | Forced air by integral fan (in drum inductive applicator)  |
| ENVIRONMENTAL CONDITIONS:  |  |
| For Transport and Storage: | Temperature: -10 to 35°C<br>Relative Humidity: 5 to 95%<br>Atmospheric Pressure: 500 to 1060 hPa   |

Each unit is supplied with a main power cable. Both the cable and the plug on the unit conform to international safety standards.

All information on supply voltages, model, serial number, and month/year of manufacture is located on the rear panel. The external fuse ratings and type information is located on the bottom of the unit.

### Standards

The Megapulse® has been designed to meet the requirements of IEC 60601-1:2001 "Safety of Medical Electrical Equipment, Part I: General requirements."

In addition the Megapulse® has been designed to meet the requirements of IEC 60601-2-3:1998 "Specification for safety for shortwave therapy equipment," and the requirements of FCC standards 47 CFR Part 18 Subpart C.

### Diagrammatic Representation of Pulse Trains

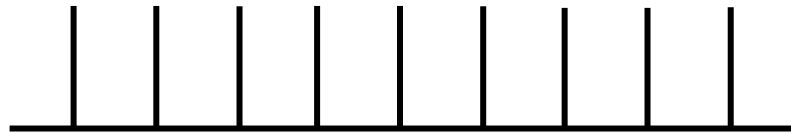

20 MICROSECOND ( $\mu$ Sec) PULSES - 800 PULSES PER SECOND (PPS)

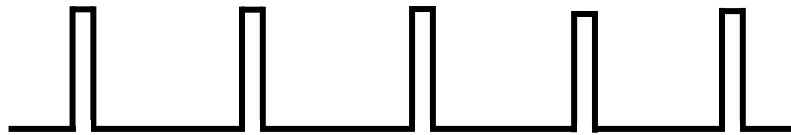

65  $\mu$ Sec PULSES - 400 PPS

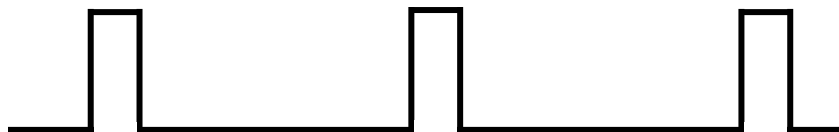

200  $\mu$ Sec PULSES - 200 PPS

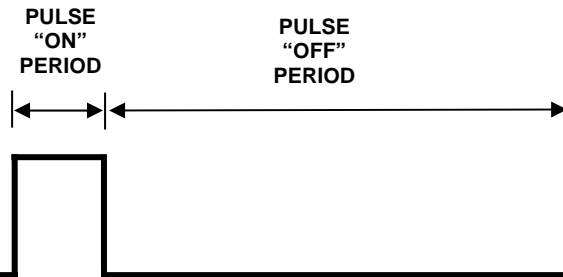

400  $\mu$ Sec PULSES - 100 PPS

#### CONTINUOUS TRAIN OF PULSES:

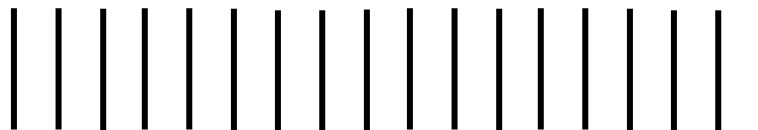

PULSES CONTAIN 27.12 MHz SINUSOIDAL R.F. AT 150 WATTS PEAK POWER 50 OHM LOAD IMPEDANCE

### Megapulse® II Average Output Power



| PULSE DURATION | AVERAGE POWER IN WATTS (W) |        |        |        |        |        | EFFECT     |
|----------------|----------------------------|--------|--------|--------|--------|--------|------------|
|                | 3.0W                       | 6.0W   | 12.0W  | 24.0W  | 36.0W  | 48.0W  |            |
| 400 µSec       | 3.0W                       | 6.0W   | 12.0W  | 24.0W  | 36.0W  | 48.0W  | 4°C        |
| 200 µSec       | 1.5W                       | 3.0W   | 6.0W   | 12.0W  | 18.0W  | 24.0W  | 2°C        |
| 100 µSec       | .75W                       | 1.5W   | 3.0W   | 6.0W   | 9.0W   | 12.0W  | 1°C        |
| 65 µSec        | .49W                       | 1.0W   | 2.0W   | 3.9W   | 5.9W   | 7.8W   | SUBTHERMAL |
| 40 µSec        | .30W                       | .6W    | 1.2W   | 2.4W   | 3.6W   | 4.8W   |            |
| 20 µSec        | .15W                       | .30W   | .60W   | 1.2W   | 1.8W   | 2.4W   |            |
| PULSE RATE     | 50 PPS                     | 100PPS | 200PPS | 400PPS | 600PPS | 800PPS |            |

*Approximate values in watts*





## MEGAPULSE® II STANDARD AND OPTIONAL ACCESSORIES

| ITEM  | ITEM NO. | DESCRIPTION  |
|---|----------|--|
|  | 1903029  | <p><b>MEGAPULSE® II<br/>SHORTWAVE DIATHERMY SYSTEM</b></p> <p>150 Watt peak power Shortwave Diathermy<br/>with Delta T control</p> <p><b>Shipping Weight: 101 lbs.</b></p> |

| ITEM  | ITEM NO. | DESCRIPTION                                  |
|---|----------|--|
|    | 29000    | Megapulse® Power Cord, Hospital Grade, 10ft. |
|   | 72763    | Applicator Head Coaxial Cable                |
|  | 89555    | Megapulse® II User Manual                    |

## Infection Control Supplies:

| ITEM  | ITEM NO. | DESCRIPTION  |
|---|----------|--|
|  | 55536    | Super Sani-Cloth® Wipes, Single Use Packets (50 pkt/bx)                  |
|   | 44425    | Super Sani-Cloth® Wipes, Tub (160/Tub)                                   |
|   | 96849    | Sani-Cloth® Wipes w/ Bleach, Tub (75 wipes/tub)                          |
|  | 52479    | Protective Film for Surfaces Infection Control – 4” x 6” (600 ft/roll)   |
|   | 50593    | Protective Film for Surfaces Infection Control – 12” x 14” (600 ft/roll) |
|  | 13296    | Megapulse® II Drum Inductive Applicator Cover (100ea/box)                |

## STANDARD LIMITED PRODUCT WARRANTY

*The warranty information provided in this section is applicable only to products purchased from ACP, directly or through an authorized dealer. This section does not apply to leased products. The terms of maintenance and repair of any leased products are detailed in the separately executed agreement between the parties.*

### **Warranty Coverage**

This warranty provides coverage, for Equipment purchased, against manufacturer's defects in material and workmanship, and extends to the original owner of the product during the warranty period for that product. Only those items returned to the ACP Service Center within the warranty period, and also within thirty (30) days after notification to ACP of the defect, shall be eligible for repair under the Standard Limited Product Warranty. Buyer is responsible for shipping cost associated with sending the Equipment to the ACP Service Center. ACP shall ship Equipment to Buyer after repair at no cost to the Buyer provided repair is deemed to be under warranty. ACP may, at its discretion and only for valid warranty claim, repair or replace any part(s) that prove to be defective during the warranty period.

### **Warranty Exclusion**

Any and all warranty coverage will be void if any of the following have occurred:

1. The product contains repairs or replacement parts not furnished by ACP.
2. The product is damaged resulting from misuse or negligence.
3. The product has been tampered with and/or altered, including serial number alteration.

**Note:** Use of the Equipment with accessories and/or supplies not approved by ACPL for use with the Equipment may void the warranty if such accessory or supply item caused damage to the Equipment.

### **Warranty Period**

The following coverage is provided at no additional cost to the Buyer:

**New Equipment / Product.** Products purchased as new from ACP are warranted against manufacturer's defects in material and workmanship for a period of two (2) years from the date of purchase.

**Refurbished Equipment / Product.** Products purchased specifically as Refurbished Equipment are warranted against manufacturer's defects in material and workmanship for a period of one (1) year from the date of purchase.

**Accessories.** All accessories for ACP equipment / products are warranted against manufacturer's defects in material and workmanship for a period of three (3) months from the date of purchase.

### **Warranty Validation**

The following information needs to be provided to the ACP Customer Support representative prior to the product being returned under warranty coverage:

1. Buyer name or account number as it appears under the "Bill TO" on the ACP or recognized ACP Dealer invoice.
2. Invoice Date and Number.
3. Model number, description, and serial number of equipment.
4. Detailed description of the problem.

## ***Return of Defective Equipment***

Any Equipment returned to the ACP Service Center under warranty coverage must have the Warranty coverage validated and must receive authorization from ACP Customer Support prior to being received at the Service Center.

Shipping charges, insurance, and any other costs incurred in sending product to ACP Service Center is the responsibility of the customer and will not be refunded. ACP shall cover the shipping charges and related costs to return the unit to the customer, provided repair is deemed to be under warranty.

ACP is not responsible for any loss or damage to the Equipment prior to receipt at the ACP Service Center. Equipment returned for warranty service must be shipped complete with all accessories (except for manuals), in its original packing or equivalent so as not to be damaged while in transit.

**Note:** Any Equipment sent to the ACP Service Center that is not covered by the ACP Limited Product Warranty is subject to a minimum service and handling fee.

### **IMPORTANT:**

**DO NOT SHIP THE EQUIPMENT TO ACP SERVICE CENTER WITHOUT FIRST SECURING AUTHORIZATION TO DO SO. PLEASE CALL CUSTOMER SERVICE AT (800)-350-1100 FOR AUTHORIZATION. EQUIPMENT SENT IN WITHOUT AUTHORIZATION FROM ACP CUSTOMER SUPPORT WILL NOT BE ACCEPTED.**

#### **Returned Materials Shipping Address:**

**Accelerated Care Plus  
Attn: ACP Service Center  
4999 Aircenter Circle, Suite 103  
Reno, NV 89502**