



---

# THERA-TRAINER MOBI USER MANUAL

---

**EN** English translation of original user manual



Congratulations!

Opting for a THERA-Trainer was a great choice. This innovative movement exerciser offers top performance “Made in Germany”.

This user manual will help you get to know your THERA-Trainer better. It will safely guide you through all functions and control options and provide you with tips and information on how to use your new exerciser best.

Before starting the unit for the first time, please read and observe chapter 2 “Safety and dangers”.

If you have any further questions or comments, your trained supplier will be happy to help.

Have fun and get moving with your THERA-Trainer.

## **Note**

*Throughout the user manual, the term THERA-Trainer means the THERA-Trainer mobi.*

*This user manual complies with Directive 93/42/EEC.  
The distributor must comply with country-specific laws/regulations.*

<b>General section</b>	<b>5</b>
<b>1 User guide</b>	<b>6</b>
1.1 Warnings	6
1.2 Notes	6
1.3 Symbols in the user manual	6
1.4 Symbols on the product	7
<b>2 Safety and dangers</b>	<b>8</b>
<b>3 Intended use</b>	<b>10</b>
3.1 Purpose	10
3.2 Medical indications	10
3.3 Instruction	11
3.4 Biocompatibility	11
<b>4 Foreseeable misuse</b>	<b>12</b>
4.1 Contraindications	12
4.2 Misuse	12
<b>5 Side effects</b>	<b>13</b>
<b>6 Scope of delivery and equipment</b>	<b>13</b>
6.1 Scope of delivery	13
6.2 Basic equipment	13
6.3 Options	13
6.4 Removable parts	14
<b>7 Overview</b>	<b>15</b>
<b>8 Start-up</b>	<b>16</b>
8.1 Unpacking	16
8.2 Set-up conditions	16
8.3 Installing the THERA-Trainer	16
8.4 Switching on or off	19
8.5 Transporting the THERA-Trainer	20
8.6 Start-up	21
<b>9 Operation</b>	<b>22</b>
9.1 Exercise preparation	22
9.2 Secure your feet	23
9.3 Secure your arms	23
9.4 Safety equipment	24
<b>User section</b>	<b>26</b>
<b>10 Training requirements</b>	<b>27</b>
10.1 Correct posture	28
10.2 Training schedule	28
10.3 Passive and active training	28
<b>11 Training with THERA-Trainer</b>	<b>29</b>
11.1 Leg exercise	29
11.2 Upper body exercise	29
<b>12 Control and display unit</b>	<b>30</b>
12.1 Display unit	32
<b>Expert section</b>	<b>34</b>
<b>13 Control and display unit</b>	<b>35</b>
13.1 Sub menu	35
13.2 Display operating hours	35
13.3 Power limits	36
<b>14 Motor power/pin force</b>	<b>36</b>
14.1 Motor power	36
14.2 Pin force	37
<b>Technical data</b>	<b>38</b>

<b>15</b>	<b>Technical data</b> .....	<b>39</b>
<b>16</b>	<b>Cleaning and disinfection</b> .....	<b>40</b>
<b>17</b>	<b>Maintenance and repairs</b> .....	<b>42</b>
17.1	Maintenance .....	42
17.2	Further use .....	42
17.3	Replacing the fuse .....	42
<b>18</b>	<b>Troubleshooting</b> .....	<b>43</b>
18.1	Control and display unit .....	43
18.2	General errors .....	44
<b>19</b>	<b>Disposal</b> .....	<b>45</b>
<b>20</b>	<b>Notes on electromagnetic compatibility</b> .....	<b>45</b>
20.1	Lines, line lengths and accessories .....	45
20.2	Warning notice regarding installation .....	45
20.3	Electromagnetic emission and immunity .....	45
20.4	Receiving and transmitting HF energy .....	45
20.5	User Information acc. to FCC15.21 .....	46
20.6	Statement for Class B digital device acc. to FCC 15.105 .....	46
20.7	Statement acc. RSS Gen Issue 4, Sect. 8.4 .....	46
<b>21</b>	<b>Warranty</b> .....	<b>46</b>

# GENERAL SECTION

## 1. USER GUIDE

The user manual and product are marked with a variety of symbols. These symbols and their functions help you to use the product safely and efficiently.

### 1.1. Warnings

#### Structure of warnings

##### **SIGNAL WORD!**

Type and source of danger!

▶ Action to avoid the danger.

#### Warning categories

##### **DANGER!**

Indicates an immediate risk which, if not avoided, will result in death or serious injury.

##### **WARNING!**

Indicates a potentially hazardous situation which, if not avoided, will result in death or serious injury.

##### **CAUTION!**

Indicates a potentially hazardous situation which, if not avoided, will result in minor or moderate injury.

##### **NOTE!**

Indicates a potentially hazardous situation which, if not avoided, will result in material or environmental damage.

### 1.2. Notes

*Information on the efficient use of the product.*

### 1.3. Symbols in the user manual

#### Instructions

Structure of instructions:

▶ Instruction to do something.

Presentation of results if required.



**Lists**

Structure of non-numbered lists:

- List level 1
  - List level 2

Structure of numbered lists:

1. List level 1
2. List level 1
  - 2.1. List level 2
  - 2.2. List level 2

**USER SECTION**

- Instructions for users.

**EXPERT SECTION**

- Instructions for trained suppliers, doctors and therapists.

**1.4. Symbols on the product**

	Observe the user manual!		Type BF medical devices
	Follow the user manual!		Do not dispose of product with the regular household waste. Dispose of product in accordance with local regulations.
	Manufacturer		Store in a dry place.
	Market launch according to Directive 93/42 EEC for medical devices	<b>IP21</b>	Protected against solid foreign bodies with a diameter as of 12.5 mm. Protection against dripping-water that falls vertically.
	Serial number		The THERA-Trainer uses alternating current.
	Protection class II device		

## 2. SAFETY AND DANGERS

### Dangers

- ▶ Before beginning the training, consult a doctor or therapist to clarify whether users with cardiovascular diseases are allowed to exercise with the THERA-Trainer.
- ▶ Use THERA-Trainer exclusively with undamaged and functional cables.
- ▶ In case of possible infection due to contaminated attachments/optional parts, always wear personal protective equipment (gloves, mask) when cleaning THERA-Trainer.

### Warning

- ▶ Observe the user manual.
- ▶ Ensure that the EMERGENCY STOP button can be reached at all times during training.
- ▶ If the user has a cardiac pacemaker, consult a doctor before the first training session.
- ▶ Before any training, make sure that safety equipment is working correctly.
- ▶ In case of amputated limbs, always wear prostheses when exercising with THERA-Trainer.
- ▶ Position the THERA-Trainer so that the power plug is easily accessible and can be pulled out of the socket outlet quickly in case of emergency.
- ▶ Position the THERA-Trainer so that the power plug is easily accessible and can be pulled out of THERA-Trainer quickly in case of emergency.
- ▶ When laying cables, make sure that
  - user's movements are not limited.
  - the movements of the THERA-Trainer are not limited.
  - there is no risk of persons falling over or being obstructed by cables.
  - there is no risk of strangulation.
- ▶ In case of damage, malfunctions, etc. of the THERA-Trainer, contact the trained supplier immediately.
- ▶ Before opening the housing, make sure that the power plug is unplugged.
- ▶ Service or repair work is only to be carried out by trained suppliers.
- ▶ Consult the manufacturer before any modification and modify the THERA-Trainer exclusively with the manufacturer's approval.

### Caution

- ▶ The manufacturer recommends having the trained supplier or the doctor or therapist show you how to use the product.
- ▶ The manufacturer recommends that, before starting the training, a doctor or therapist be consulted to determine whether the THERA-Trainer can be used without assistance.
- ▶ The manufacturer recommends that, before starting the training, a doctor or therapist be consulted to determine which training parameters match the user's fitness.
- ▶ If any symptoms of illness occur during or after training, seek medical advice immediately.
- ▶ The manufacturer recommends that, before starting the training, a doctor or therapist be consulted to determine which pin forces can act on the user.
- ▶ Prior to start-up, have your trained supplier, doctor or therapist instruct the assistant.
- ▶ Select range of motion to match the user's fitness.
- ▶ Limit motor power as required for the user and his or her training state.
- ▶ Use THERA-Trainer exclusively in good and functional condition.
- ▶ Place THERA-Trainer on even and slip-proof floor.
- ▶ Place THERA-Trainer on a stable and height-adjustable table with a slip-proof surface.



- ▶ Exercise exclusively with THERA-Trainer standing levelly on its feet.
- ▶ Place chair/wheelchair on even and slip-proof floor.
- ▶ Make sure that foot rests or therapy grips click properly into place.
- ▶ Take care not to pinch any fingers when adjusting settings on the THERA-Trainer.
- ▶ Wear closed shoes when exercising with shoes on.
- ▶ Tuck shoelaces into shoes.
- ▶ Wear close-fitting clothes.
- ▶ Do not wear jewellery or other accessories while exercising.
- ▶ Tie back hair when longer than shoulder-length.
- ▶ Exercise exclusively with two therapy grips or two foot rests.
- ▶ Exercise exclusively with both feet correctly positioned in the foot rests.
- ▶ Exercise exclusively when both hands are able to grip and hold the therapy grips, or are secured with wristbands for therapy grips.
- ▶ Do not stand on covers or in foot rests.
- ▶ For leg exercise, use THERA-Trainer exclusively in a sitting position.
- ▶ For upper body exercise, use THERA-Trainer in a sitting or standing position.
- ▶ Always position THERA-Trainer correctly (forward) for exercising (control and display unit pointing toward user).
- ▶ Make sure that open sides of installed foot rests point away from user.
- ▶ Always supervise children during training.
- ▶ Keep animals and playing children away from THERA-Trainer.
- ▶ Change foot rests or therapy grips exclusively when THERA-Trainer is without power or in the STOP mode.
- ▶ When exercising in an electric wheelchair, switch off electronic control/driving function.
- ▶ Make sure that the user exercises with a stable chair that will not wobble or tip over.
- ▶ Before every training session using a chair with castors, make sure that
  - it is possible to lock the castors.
  - inadvertent unlocking of the castors while exercising is not possible.
- ▶ Make sure that the chair/wheelchair does not tip over backwards.
- ▶ Do not touch moving parts (e.g. crank axle, foot rests, etc.).

**Note**

- ▶ Exercise exclusively with THERA-Trainer, if THERA-Trainer was started with the START button.
- ▶ Leave THERA-Trainer at room temperature for 1 hour before using it for the first time.
- ▶ Make sure that THERA-Trainer does not get wet.
- ▶ Make sure that no liquids get into THERA-Trainer.
- ▶ Use THERA-Trainer exclusively with correctly set supply voltage.
- ▶ Do not use THERA-Trainer in wet, humid or hot environments.
- ▶ Do not use THERA-Trainer as a standing aid.
- ▶ Use exclusively the manufacturer's original parts.
- ▶ Use exclusively the options listed by the manufacturer.
- ▶ Exercise exclusively when THERA-Trainer is switched on.
- ▶ Make sure that THERA-Trainer or chair/wheelchair or table does not slip while exercising.
- ▶ Do not smoke while exercising.
- ▶ Make sure that the helix cable of the control and display unit with control and display unit mobi 2.7" wireless does not become entangled in the therapy grips or foot rests.

- ▶ Pull power plug after every training session.
- ▶ Use exclusively the power cable supplied by the manufacturer.
- ▶ Use exclusively cleaning agents and disinfectants approved by the manufacturer.

### **3. INTENDED USE**

#### **3.1. Purpose**

The THERA-Trainer is a training device for the mobilisation of users with minor physical and/or mental impairments, in neurological, age-related or chronic degenerative diseases. The THERA-Trainer is suitable:

- as a training device for the legs (sitting) or the upper body (sitting or standing).
- for passive (with motor power), assistive (with motor assistance) and active (with muscle power) exercise training.
- for use at home and in institutions (e.g. hospitals, nursing homes, therapy practices, etc.).
- for users whose height is between 120 and 200 cm (depending on the type of wheelchair or chair used for the training).
- for the use of a stable, upright seat (e.g. non-tilting chair or wheelchair, etc.) or standing.
- for users who weigh less than 140 kg.
- for maintaining or improving mobility and muscle power.
- for stimulating metabolism and circulation.
- for users with leg or arm prostheses, with a maximum difference weight of 6 kg per side.



*The THERA-Trainer is a medical device according to the medical devices directive. The intended use includes the treatment of the device as a medical device.*



*If THERA-Trainer is used as intended, no additional action is required for users with active medical implants (pacemaker, defibrillator) to ensure their safety.*

#### **3.2. Medical indications**

Use the THERA-Trainer exclusively:

- for users with no or minor physical impairments of arms or legs.
- for users with no or minor mental impairments.
- for users who are able to sit upright (leg and upper body training).
- for users who are able to stand upright (exclusively upper body training).
- for users with reduced power and endurance.

When training without an assistant, use the THERA-Trainer exclusively:

- for users who are able to operate the THERA-Trainer without assistance.



*The manufacturer recommends that, before starting the training, a doctor or therapist be consulted to determine whether the THERA-Trainer can be used without assistance.*

#### **Users**

- Persons who are able or authorised to use the THERA-Trainer and exercise with the THERA-Trainer using the user manual, having received instruction from expert staff.
- The user is entirely responsible for the safe and correct use of the THERA-Trainer.
- The manufacturer recommends an introduction of the product be given by your supplier, doctor or therapist before start-up.

### **Specialised staff**

- ❑ Persons who gained their skills and expertise by means of professional training in the medical or medical-technical sector (e.g. doctors, therapists, trained suppliers).
- ❑ Persons who due to their professional experience and by means of instruction/training by the manufacturer are able to assess safety-relevant regulations and recognise potential risks in their field of work (e.g. assistants).
- ▶ To guarantee safe use of the THERA-Trainer, train expert staff regularly.

### **3.3. Instruction**

- ▶ Read and observe the user manual.

Before the first start-up, the manufacturer recommends:

- ▶ An introduction by a person trained by the manufacturer.
- ▶ Consulting a doctor or therapist to determine whether training with the THERA-Trainer is possible without supervision.
- ▶ Have an assistant instructed by a person trained by the manufacturer.

### **3.4. Biocompatibility**

All components and options of the THERA-Trainer the user will touch when using the unit as intended are designed to meet the biocompatibility requirements of the applicable standards.

- ▶ For any questions, contact a trained supplier.

## 4. FORESEEABLE MISUSE

The THERA-Trainer is not suitable:

- for diagnostic purposes
- for monitoring
- for measuring
- for competitive sports

### 4.1. Contraindications

Do not use the THERA-Trainer in the case of:

- users with serious contractures.
- users with ulcers or raw skin that would touch the unit (if in doubt, seek medical advice).
- bone instability / bone metabolism disorders (fractures, osteoporosis, osteogenesis imperfecta).
- users with major physical or mental impairments (e.g. spasticity, plegie or severe paresis, contractures, etc.).
- users with intense spasticities or high tonicity.
- in case of restrictions of cognitive or sensory perception.
- amputated limbs not replaced by prostheses.
- acute inflammations - e.g. of the joints.
- acute thrombosis.
- acute neurological deficiencies.
- recently herniated discs.
- previously damaged tendons (risk of rupture).

Use THERA-Trainer in consultation with a doctor or therapist in the case of:

- severe pain during exercise.
- dislocation of the shoulder and hip.
- COPD (chronic obstructive pulmonary disease).
- heart failure.
- cardiovascular weakness.
- artificial hearts.

### 4.2. Misuse

Do not use the THERA-Trainer as:

- a replacement for movement exercisers suitable for major physical or mental impairments (e.g. THERA-Trainer tigo, THERA-Trainer veho).

Do not use the THERA-Trainer:

- in combination with other products emitting ionising radiation (e.g. radiation therapy, nuclear medicine, etc.).
- in rooms with
  - explosive substances
  - oxygenated air
- in the presence of
  - flammable anaesthetics
  - volatile solvents
- for outdoor exercise.
- in ambient conditions not conforming to the requirements.
- in a lying position.
- for unsupervised training, if the user cannot operate the THERA-Trainer without assistance.
- in the vicinity of RF surgical equipment and in RF shielded rooms with medical magnetic resonance imaging systems.

## 5. SIDE EFFECTS

In rare cases:

- partially increased pain
- partially excessive muscle tone reduction
- injuries of the skin (e.g. decubitus)

*No other side effects are known.*



## 6. SCOPE OF DELIVERY AND EQUIPMENT

The THERA-Trainer comes with individual options. This user manual describes all options available for the THERA-Trainer. Depending on the equipment variant, the user manual may include options not featured by the THERA-Trainer. If options for the THERA-Trainer are not described in the user manual, an appendix is included.

### 6.1. Scope of delivery

The delivery note contains all information about the scope of delivery.

### 6.2. Basic equipment

Basic equipment of the THERA-Trainer:

- Base unit
- Foot rests
- Therapy grips
- Control and display unit mobi 2.7" - wireless
- Software package
- User manual for THERA-Trainer
- Power cable

### 6.3. Options

Available options:

- Wristbands for therapy grips
- Carry bag for the THERA-Trainer
- THERA-soft
- Wireless receiver for PC



*Use exclusively the options listed by the manufacturer.*



## 6.4. Removable parts

Removable parts of the THERA-Trainer:

	Name	Article no.
	Foot rests	A003-974
	Velcro for foot rests	40000552-000
	Therapy grips	A001-420
	Wristbands for therapy grips	A002-440
	Control and display unit mobi 2.7" wireless	A006-172
	Carry bag for the THERA-Trainer	A003-976

	Name	Article no.
	Power cable (length: 5.0 m each) <input type="checkbox"/> EU SKII type C: H05VV-F 2x1.0 mm <sup>2</sup> <input type="checkbox"/> CH SKII type J: H05VV-F 2x1.0 mm <sup>2</sup> <input type="checkbox"/> GB SKII type G: H05VV-F 2x1.0 mm <sup>2</sup> <input type="checkbox"/> US SKII type A: STJ 2xAWG 18 <input type="checkbox"/> CN SKII type A: RVV 2xAWG 18 <input type="checkbox"/> JP SKII type A: VCTF 2xAWG 18 <input type="checkbox"/> AU SKII type I: H05VV-F 2x1.0 mm <sup>2</sup>	A004-805 A004-807 A004-809 A004-810 A004-811 A004-812 A004-813
	Wireless receiver for PC	A004-020

## 7. OVERVIEW



- (1) Foot rest (application part type BF)
- (2) Crank disc
- (3) Control and display unit mobi 2.7" - wireless
- (4) Holder for control and display unit
- (5) Helix cable
- (6) Therapy grip (application part type BF)
- (7) Height-adjustable foot
- (8) Base unit

## 8. START-UP

### **⚠ WARNING!**

#### **Danger to life due to magnetic field!**

- ▶ Make sure that there is no direct body contact with the THERA-Trainer in the vicinity of the pacemaker or defibrillator.
- ▶ Maintain a safety distance of at least 5 cm.

### 8.1. Unpacking

Unpack the THERA-Trainer:

- ▶ Remove the THERA-Trainer from packaging.
- ▶ Check the THERA-Trainer incl. all accessories/options for transport damage.
- ▶ Check if delivery is complete.
- ▶ Inform supplier or forwarding agent immediately of any damage.

### 8.2. Set-up conditions

- ▶ For safe and effective use, observe the following conditions.
- Ambient conditions during use:
  - Temperature: 5 °C - 40 °C
  - Humidity: 15 % - 93 % Rh
  - Air pressure: 700 hPa - 1,060 hPa
  - Do not use THERA-Trainer in wet, humid or hot environments.
  - For leg exercise, always place the THERA-Trainer on an even and slip-proof surface (floor).
  - For upper body exercise, put the THERA-Trainer exclusively on a stable and height-adjustable table with a slip-proof surface.
  - Do not use the THERA-Trainer for outdoor exercise.

### 8.3. Installing the THERA-Trainer

#### Installing foot rests

### **⚠ CAUTION!**

#### **Risk of injury due to incorrectly installed foot rests!**

- ▶ Make sure that open sides of installed foot rests point away from user.
- ▶ Slide foot rests onto crank axle up to the stop.
- ▶ Make sure that the locking bolt audibly clicks into place.

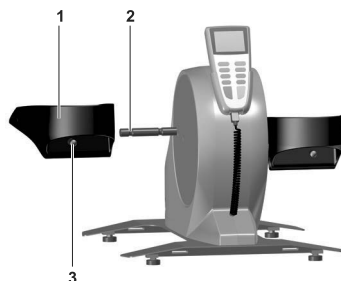

- ▶ Press locking bolt 3.
- ▶ Slide foot rests 1 onto crank axle 2 up to the stop.
- ▶ Release locking bolt.
- ▶ Make sure that locking bolts audibly click into place.



## Installing therapy grips

### **⚠ CAUTION!**

#### **Risk of injury due to incorrectly installed therapy grips!**

- ▶ Slide therapy grips 2 onto crank axle 1 up to the stop.
- ▶ Make sure that the locking bolt audibly clicks into place.

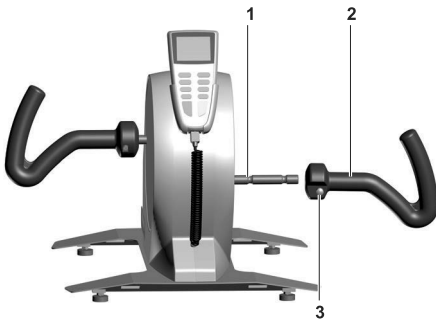

- ▶ Press locking bolt 3.
- ▶ Slide therapy grips 2 onto crank axle 1 up to the stop.
- ▶ Release locking bolt.
- ▶ Make sure that locking bolts audibly click into place.

## Adjusting height-adjustable feet



*To level out unevenness of the floor, it is possible to adjust the height of the device's feet to improve the stability and slip resistance of the THERA-Trainer.*



Adjust feet (4) as follows:

- ▶ Make sure that the THERA-Trainer is without power, pull power plug if necessary.
- ▶ Unscrew lock nuts 1 using a suitable tool.
- ▶ Adjust feet 2 to required height.
- ▶ Make sure that the THERA-Trainer is levelled.
- ▶ Tighten lock nuts and verify tightness.
- ▶ Make sure that feet of device are dry and free of dust.
- ▶ The manufacturer recommends cleaning the device's feet before every training session.

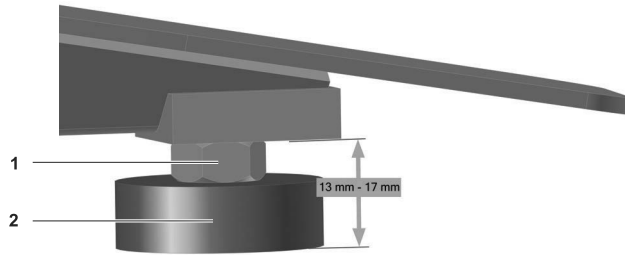

*The height-adjustable feet serve exclusively to level out unevenness. The maximum adjusting height between surface and metal frame is 13 mm to 17 mm. If the adjusting range of 4 mm max. is not respected, it is possible for the lock nut to damage the thread.*

### Connecting the control and display unit

#### NOTE!

##### Material damage due to incorrect installation!

- ▶ Make sure that plug is plugged in the socket correctly when connecting cable.
- ▶ Observe position of plug.
- ▶ Make sure that during operation of the THERA-Trainer only the control and display unit with article no. A006-172 is connected.
- ▶ Make sure that only the control and display unit with article no. A006-172 is connected to the helix cable.

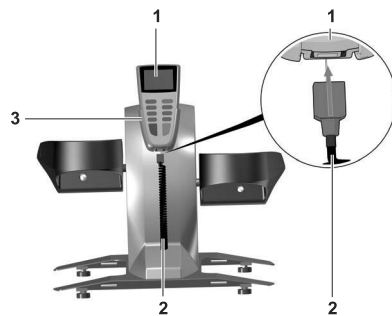

- ▶ Make sure THERA-Trainer is de-energised.
- ▶ Plug helix cable **2** into control and display unit **1**.

Control and display unit is correctly connected when plug connector audibly clicks into place.

- ▶ Place control and display unit in the intended holder **3**.

## Connecting the power cable

### NOTE!

#### Material damage due to incorrect installation!

- ▶ Make sure that plug is plugged in the socket correctly when connecting cable.
- ▶ Observe position of plug.

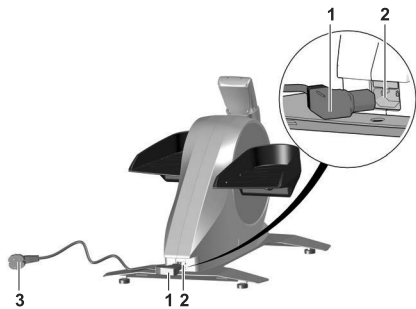

- ▶ Use exclusively the power cable supplied by the manufacturer.
- ▶ Connect plug 1 to port 2.
- ▶ Connect power plug 3 to socket outlet.

The THERA-Trainer is ready for use.

## 8.4. Switching on or off

### ⚠ CAUTION!

#### Risk of injury due to the THERA-Trainer starting up.

- ▶ Make sure that no arms or legs are in the THERA-Trainer during start-up.

To switch on the THERA-Trainer:

- ▶ Connect power plug to socket outlet.
- ▶ Use exclusively the power cable supplied by the manufacturer.

THERA-Trainer boots up.

Display during start-up (automatically in succession for approx. 3 seconds):

1. All elements of the control and display unit that can be displayed (for function-control purposes)
2. Device type (mobi)
3. current setting of the sub menu
4. software version of the control and display unit
5. software version of the main controller board
6. Operating hours

Following the start-up, the THERA-Trainer is ready for operation.

## Switching on

**Stand-by mode**

The THERA-Trainer will switch to stand-by mode when

- ❑ no button is pressed for approx. 5 minutes (not during training).

A beep will sound and the screen backlight will turn off.

To activate the THERA-Trainer:

- ▶ Press any button on the control and display unit.

Beep will sound and THERA-Trainer boots up.

Following the start-up, the THERA-Trainer is ready for operation.

**Switching off**

To switch off the THERA-Trainer:

- ▶ Remove power plug from power socket.

**8.5. Transporting the THERA-Trainer**

**⚠ WARNING!**

**Danger to life due to magnetic field!**

- ▶ Make sure that there is no direct body contact with the THERA-Trainer in the vicinity of the pacemaker or defibrillator.
- ▶ Maintain a safety distance of at least 5 cm.

**⚠ CAUTION!**

**Risk of injury due to incorrect transport!**

- ▶ Make sure that the THERA-Trainer is exclusively transported by a person who is able to bear approx. 13.5 kg of weight.
- ▶ Carry the THERA-Trainer exclusively with both hands.
- ▶ Make sure that the THERA-Trainer does not slip out of your hands while you are transporting it.
- ▶ Carry the THERA-Trainer exclusively with dry and grease-free hands.

**NOTE!**

**Damage due to incorrect transport!**

- ▶ Always lift or transport the THERA-Trainer with both hands on the base unit.
- ▶ Do not carry THERA-Trainer by foot rests/therapy grips or crank axle.

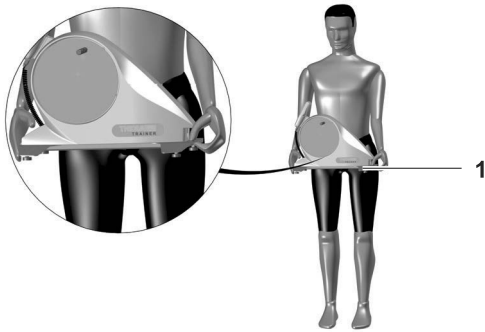

Without a carry bag, transport the THERA-Trainer as follows:

- ▶ Pull power plug.
- ▶ If necessary, remove foot rests/therapy grips.
- ▶ Hold the THERA-Trainer by base unit **1** with both hands.
- ▶ Take the THERA-Trainer to the desired position.
- ▶ Install foot rests/therapy grips.

With a carry bag, transport the THERA-Trainer as follows:

- ▶ Open carry bag.
- ▶ Observe instructions for use of carry bag (included).
- ▶ Pull power plug.
- ▶ Remove foot rests/therapy grips.
- ▶ Hold the THERA-Trainer by base unit with both hands.
- ▶ Put the THERA-Trainer into carry bag.
- ▶ Take control and display unit out of holder.
- ▶ Stow control and display unit/foot rests and therapy grips securely.
- ▶ Close carry bag.
- ▶ Take the THERA-Trainer to the desired position.
- ▶ Open carry bag.
- ▶ Place control and display unit into holder.
- ▶ Take the THERA-Trainer out of the carry bag by base unit with both hands, and put onto floor or table.
- ▶ Install foot rests/therapy grips.

## **8.6. Start-up**

Starting up the THERA-Trainer:

- ▶ Connect power plug to socket outlet.

THERA-Trainer boots up.

Following the start-up, the THERA-Trainer is ready for operation.

## 9. OPERATION

### 9.1. Exercise preparation

#### **DANGER!**

##### **Risk of infection due to contaminated THERA-Trainer!**

- ▶ Wear gloves during cleaning and disinfection.
- ▶ Observe general precautions to prevent users from being exposed to blood-borne pathogens.
- ▶ Wear personal protective equipment (gloves, masks, lab coats) when contact to bodily fluids such as saliva, blood, semen or vaginal secretion is likely to occur.
- ▶ No direct patient contact by health care professionals who have weeping wounds or skin inflammations.
- ▶ When having direct patient contact as a health care professional who has weeping wounds or skin inflammations, wear appropriate protective clothing (gloves, scrub caps, etc.).

#### **WARNING!**

##### **Danger to life due to magnetic field!**

- ▶ Make sure that there is no direct body contact with the THERA-Trainer in the vicinity of the pacemaker or defibrillator.
- ▶ Maintain a safety distance of at least 5 cm.

#### **CAUTION!**

##### **Risk of injury due to tipping over or slipping of the THERA-Trainer!**

- ▶ Place the THERA-Trainer on even and slip-proof floor.
- ▶ Place chair/wheelchair on even and slip-proof floor.
- ▶ Place THERA-Trainer on a stable and height-adjustable table with a slip-proof surface.
- ▶ Position the THERA-Trainer so that the power plug is easily accessible and can be pulled out of the socket outlet quickly in case of emergency.
- ▶ Make sure that feet of device are dry and free of dust.

#### **CAUTION!**

##### **Risk of injury through insufficient preparation!**

- ▶ Disinfect the THERA-Trainer before every training (see chap. 16. Cleaning and disinfection).
- ▶ Make sure that foot rests or therapy grips are moving freely.

#### **CAUTION!**

##### **Risk of injury due to trapped shoelaces, clothes or accessories!**

During training:

- ▶ Wear closed shoes when exercising with shoes on.
- ▶ Tuck shoelaces into shoes.
- ▶ Wear close-fitting clothes.
- ▶ Do not wear jewellery or other accessories while exercising.
- ▶ Tie back hair when longer than shoulder-length.

**⚠ CAUTION!**

**Danger of injury due to insufficient support!**

If necessary:

- ▶ Secure feet with velcros.
- ▶ Secure hand using optional wristbands for therapy grips.

## 9.2. Secure your feet

### Secure feet with loop tape



If necessary, secure feet in foot rests as follows:

- ▶ Make sure that the THERA-Trainer is not in training mode.
- ▶ Make sure that feet are correctly positioned in foot rests **1**.
- ▶ Wrap velcros **2** tightly around instep of the foot.
- ▶ Fasten velcros on outside of the foot rests.

*If the foot fixing is not sufficient for the user to exercise safely, the manufacturer recommends using THERA-Trainer tigo.*



## 9.3. Secure your arms

### Therapy grips

- Offer variable grip positions.
- Are exclusively usable when the user's ability to safely hold the grips is sufficient.
- ▶ If necessary, use wristband to secure hand on therapy grip.
- ▶ Securing both hands is exclusively possible with the help of an assistant.

### Securing hand using wristbands for therapy grips

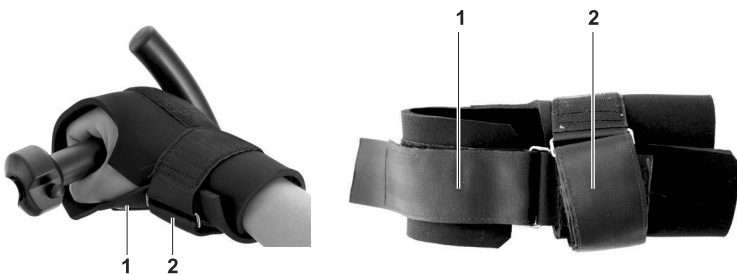

*The wristbands for therapy grips allow paralysed/weakened hands to be fixed quickly and easily to the therapy grips.*



Securing both hands is exclusively possible with the help of an assistant.

- ▶ Always have an assistant supervise training sessions with two secured hands.
- ▶ With only one secured hand, unassisted training is possible.
- ▶ For cleaning the wristbands, see chap. 16. Cleaning and disinfection.

Secure hand(s) as follows:

- ▶ Put open wristband for therapy grips on table or thigh.
- ▶ Put hand into wristband for therapy grips.
- ▶ Thread velcro **2** through bracket and secure wrist.
- ▶ Put paralysed/weakened hand around therapy grip.
- ▶ Thread velcro **1** through bracket and secure paralysed/weakened hand on the-  
rapy grip.

#### **9.4. Safety equipment**

##### **CAUTION!**

**Risk of injury due to damaged safety equipment.**

- ▶ Before every training, make sure that safety equipment is working correctly.
- ▶ Have malfunctions repaired by trained suppliers.

##### **EMERGENCY STOP button**

- ▶ Press the EMERGENCY STOP button in dangerous situations.

The THERA-Trainer stops immediately and the number of revolutions and the training resistance slow down to 0.

The control and display unit displays STOP.

To arrange for the EMERGENCY STOP:

- ▶ Press START button.

- OR -

- ▶ Pull power plug.
- ▶ Wait 5 seconds.
- ▶ Connect power plug.

If the THERA-Trainer immediately starts with the training after you have pressed the START button:

- ▶ Press EMERGENCY STOP button.
- ▶ Contact trained supplier and notify them about the defect.
- ▶ Do not use the THERA-Trainer for further training.

The THERA-Trainer is in START mode.

- ▶ Press the START button again to start the new training session.



### **Block foot rests/therapy grips**

Triggering the blocking, for example through excessive tonicity or sudden spasmodic movement.

In the event of blocking:

- After approx. 3 seconds, the control and display unit shows **bloc**.
- An acoustic signal is played.
- You can stop the blocking within approx. 5 seconds.  
If the blocking is stopped within approx. 5 seconds, you can continue training.
- After approx. 5 seconds, the THERA-Trainer switches to blocked mode.  
The THERA-Trainer stops and the number of revolutions and the exercising resistance slow down to 0.
- An acoustic signal is played.
- ▶ Check the reason for the blocking and rectify it where required.
  - Make sure that foot rests or therapy grips are moving freely.
  - Make sure that you prevent overstretching.
  - Increase motor power if required.

To leave the blocked mode:

- ▶ Press START button.
- ▶ Press the START button again to start the new training session.

*The THERA-Trainer is not suitable for users with high tonicity or spasmodic movements. The manufacturer recommends THERA-Trainer tigo or THERA-Trainer veho in this case.*



# USER SECTION



*The user section addresses the user and describes how to use the THERA-Trainer.*

## 10. TRAINING REQUIREMENTS

### WARNING!

#### **Danger to life due to magnetic field!**

- ▶ Make sure that there is no direct body contact with the THERA-Trainer in the vicinity of the pacemaker or defibrillator.
- ▶ Maintain a safety distance of at least 5 cm.

### CAUTION!

#### **Risk of injury through insufficient preparation!**

- ▶ Disinfect the THERA-Trainer before every training (see chap. 16. Cleaning and disinfection).
- ▶ Before every training session, clean feet of device to improve stability and slip resistance.
- ▶ Make sure that foot rests or therapy grips audibly click into place.
- ▶ Make sure that the range of motion is appropriate for the user.
- ▶ Make sure that foot rests or therapy grips are moving freely.

### CAUTION!

#### **Danger of injury due to insufficient support!**

If necessary:

- ▶ Secure feet with velcros.
- ▶ Secure hand using optional wristbands for therapy grips.

Before starting the training:

- ▶ The manufacturer recommends consulting a trained supplier/doctor to clarify whether safe exercise is possible without an assistant.
- ▶ Undergo instruction from trained supplier.
- ▶ Read the user manual.
- ▶ Position the THERA-Trainer so that the power plug is easily accessible and can be pulled out of the socket outlet quickly in case of emergency.
- ▶ The manufacturer recommends having a doctor or therapist compile a training schedule.
- ▶ Make sure that the chair/wheelchair does not tip over.
- ▶ Make sure that the parameters fit the user's individual needs (motor power, exercise time, exercising resistance, number of revolutions etc.).
- ▶ Make sure that the range of motion is adapted to fit the user's individual needs, e.g. by modifying the sitting position.
- ▶ Before starting the leg exercise, make sure that foot rests are moving freely. Turn foot rests with legs manually (using muscle power).
- ▶ Before starting the upper body exercise, make sure that therapy grips are moving freely. Turn the therapy grips with the hands manually (using muscle power).
- ▶ Contact your doctor, therapist or trained supplier if you have any questions, problems, or if error messages are displayed.

During training:

- ▶ Start training slowly.
- ▶ Increase training to 70 % of individual performance limit.
- ▶ Avoid overstrain (e.g. overstretching of the joints).
- ▶ Secure arms or legs sufficiently.
- ▶ Make sure that you can reach the control and display unit at any time to stop the THERA-Trainer in emergency situations.

### 10.1. Correct posture

- ▶ Sit upright when exercising in a sitting position (for leg and upper body exercise).
- ▶ Stand upright when exercising in a standing position (for upper body exercise).
- ▶ Assume physiological training position.
  - if necessary, consult doctor or therapist.

### 10.2. Training schedule

To improve mobility, strength and endurance:

- ▶ Exercise regularly.
- ▶ Exercise in short units to avoid overstrain.
- ▶ Begin with training sessions of max. 15 minutes.
- ▶ Start with slow passive exercise to warm up and then switch to light active exercise with little exercising resistance.
- ▶ Increase training time and speed in small steps and do more active muscular exercise with higher exercising resistance.



*Several training sessions per day are possible, provided that there are no negative side effects and the user's individual capacity is not exceeded.*

### 10.3. Passive and active training

#### Passive training

- THERA-Trainer moves the user.
  - The users do not use their own muscle power.
- THERA-Trainer provides the required energy.
- When switched on, the THERA-Trainer will always start with passive exercise at the set number of revolutions.
- By actively moving the user in the same direction, the THERA-Trainer will automatically switch to active exercise.

#### Active training

- The user uses his own muscle power to work against the set training resistance

## 11 TRAINING WITH THERA-TRAINER

 <b>CAUTION!</b>
<p><b>Risk of injury due to lack of independence!</b>          If the user cannot operate the THERA-Trainer without assistance:</p> <ul style="list-style-type: none"> <li>▶ Make sure that the user exercises exclusively with a trained assistant.</li> </ul>

 <b>CAUTION!</b>
<p><b>Danger of injury due to unsuitable chair/wheelchair.</b></p> <ul style="list-style-type: none"> <li>▶ Make sure that the chair/wheelchair does not tip over or slip.</li> <li>▶ Use exclusively chairs/wheelchairs with backrests of sufficient height.</li> </ul>

To start the training:

- ▶ Position a stable chair or wheelchair/electric wheelchair with a back of sufficient height in front of the THERA-Trainer.  
 When using a wheelchair/electric wheelchair, put on the brakes.
- ▶ Before every training session using a chair with castors, make sure that
  - it is possible to lock the castors.
  - inadvertent unlocking of the castors while exercising is not possible.
- ▶ For leg exercise, place THERA-Trainer on an even and slip-proof floor.
- ▶ For upper body exercise, put THERA-Trainer on a stable and height-adjustable table with a slip-proof surface.
- ▶ Before starting the training session, make sure that foot rests or therapy grips are moving freely.
- ▶ Depending on the type of training,
  - place legs in foot rests and secure if necessary.
  - hold therapy grips. secure hands if necessary.
- ▶ Ensure that the EMERGENCY STOP button can be reached at all times during training.
- ▶ Press START button on control and display unit.

### 11.1. Leg exercise

- ▶ The THERA-Trainer permits active or passive leg exercise.
- ▶ Make sure that foot rests are safely attached to the crank axle when exercising the legs.
- ▶ Do not stand in foot rests.
- ▶ Exercise exclusively with both feet in the foot rests.

### 11.2. Upper body exercise

- ▶ The THERA-Trainer permits active or passive upper body exercise.
- ▶ Make sure that therapy grips are safely attached to the crank axle when doing upper body exercises.
- ▶ Make sure that user is able to hold therapy grips. If necessary, secure hands on therapy grips using wristbands for therapy grips.
- ▶ Always exercise with two therapy grips.

## 12 CONTROL AND DISPLAY UNIT

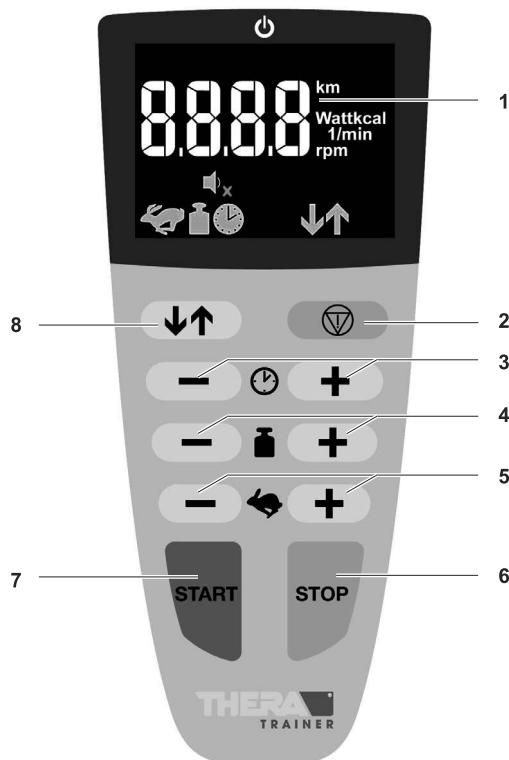

- (1) Training parameters display
- (2) EMERGENCY STOP button
- (3) Training time buttons
- (4) Exercising resistance buttons
- (5) Number of revolutions buttons
- (6) STOP button
- (7) START button
- (8) Direction of rotation button

Safe handling of the control and display unit:

- ▶ Make sure that you can reach the control and display unit at any time to stop THERA-Trainer in emergency situations.
- ▶ Make sure that helix cable of the control and display unit does not get tangled in the therapy grips or foot rests.

### Functions of the control and display unit

- ▶ Press button: THERA-Trainer starts countdown and begins the training session. **START button**

The THERA-Trainer starts at 10 rpm.

- ▶ Press button: THERA-Trainer pauses ongoing training session (-P-). **STOP button**
- ▶ Press button again: THERA-Trainer stops training session.

Control and display unit shows report of the training session:

- Indicates covered distance in km.
- Indicates energy consumption in kcal.

- ▶ Press button: the THERA-Trainer stops training immediately. **EMERGENCY STOP button**
- In dangerous situations, the number of revolutions and the exercising resistance immediately slow down to 0 when you press the EMERGENCY STOP button.
- The control and display unit displays STOP.

To leave the EMERGENCY STOP:

- ▶ Press START button.

- OR -

- ▶ Pull power plug.
- ▶ Wait 5 seconds.
- ▶ Connect power plug.

If the THERA-Trainer immediately starts with the training after you have pressed the START button:

- ▶ Press EMERGENCY STOP button.
- ▶ Contact trained supplier and notify them about the defect.
- ▶ Do not use the THERA-Trainer for further training.

The THERA-Trainer is in START mode.

- ▶ Press the START button again to start the new training session.
- Indicates training parameters alternatingly during the training session. **Training parameters display**
- ▶ Press button: Rotation direction arrow changes. The THERA-Trainer changes direction. **Direction of rotation button**
- The THERA-Trainer gradually reduces the number of revolutions to 0 rpm and resumes movement in the opposite direction with a pre-set number of revolutions.
- The yellow arrow indicates the direction of rotation currently set.
  - Arrow up: forward direction of rotation
  - Arrow down: backward direction of rotation
- ▶ Press + button: Rabbit symbol flashes. THERA-Trainer gradually increases the number of revolutions. **Buttons Number of revolutions**
- ▶ Press - button: Rabbit symbol starts flashing. The THERA-Trainer gradually reduces the number of revolutions.
- ▶ Press and hold + button to increase the number of revolutions continuously until maximum is reached.
- ▶ Press and hold - button to reduce the number of revolutions continuously until minimum is reached.
- Adjustment range for passive training: 0-60 rpm
- Maximum number of active revolutions: 1-90 rpm

**Exercising resistance button**

- ▶ Press + button: Weight symbol starts flashing. The THERA-Trainer gradually increases exercising resistance.
- ▶ Press - button: Weight symbol starts flashing. The THERA-Trainer gradually reduces exercising resistance.
- ▶ Press and hold +/- button: Increase or reduce exercising resistance continuously until maximum or minimum is reached.
- Current exercising resistance is adjustable in 15 steps (0-15).
- Exercising resistance setting will remain constant within the entire rpm range.
- Higher pedalling frequency = higher performance.



*The levels of the exercising resistance divide up the motor power that is set, i.e. if the motor power is set to 6 Nm, the motor power is divided into 15 levels. Example: At level 10, the motor power is 4 Nm.*

**Training time button**

- ▶ Press + button: Clock symbol starts flashing. The THERA-Trainer increases the training time.
- ▶ Press - button: Clock symbol starts flashing. The THERA-Trainer reduces the training time.
- ▶ Press and hold +/- button: Increase or reduce training time continuously until maximum or minimum is reached.
- Factory setting: 15 min
- Adjustment range: 1-180 min.

**Saving training settings**

You can save individual training settings before starting:

- Direction of rotation
- Training time

Every subsequent training session will start with these settings. An interruption of the power supply will reset the settings to the factory settings.

**12.1. Display unit**



- (1) Stand-by mode display
- (2) Training parameters display
- (3) Status bar display
- (4) Key sound ON/OFF display
- (5) Display of wireless icon

**Explanation of display unit**

**Stand-by mode display**

- If no button of the THERA-Trainer has been pressed for more than 5 minutes (not during exercising),
  - the screen light of control and display unit switches off.
  - LED 1 lights up.
- ▶ Press any button to switch THERA-Trainer to operating mode.









- During a training session, the training parameters display automatically alternates every 5 seconds. The following training parameters are displayed:
  - number of revolutions (1/min)
  - power (watt)
  - energy consumption (kcal)
  - distance (km)
  - remaining training time (min.)
- ▶ Press START button: Automatic change of training parameters deactivated.
  - Currently shown training parameter is displayed. (training parameter unit starts flashing).
- ▶ Press START button again: Automatic switch of training parameters activated.

**Training parameters display**

Display of the training evaluation:

- Automatically once the current training session has finished.
- As long as possible until any button **excluding** the START button is pressed.
- Possible until the power supply is interrupted.
- Automatically ends after approx. 30 seconds.
- Indicates covered distance in km.
- Indicates energy consumption in kcal.
- Alternate between the distance covered and energy consumption using the direction of rotation button.
- Automatically switches between display of distance covered and energy consumption every 5 seconds.

**Display Training evaluation**

-  Number of revolutions symbol
-  Exercising resistance symbol
-  Training time symbol
-  Direction of rotation symbol
-  Icon wireless connection
-  Symbol sub menu

**Status bar display**

- Key sound ON: Loudspeaker displayed.
- Key sound OFF: Crossed-out loudspeaker displayed.

**Key sound ON/OFF display**

- Wireless connection present: Wireless symbol active (symbol is present).
- Wireless connection inactive: Wireless symbol in inactive (symbol is not present).
- Beep when disconnecting or establishing the connection.

**Display Wireless connection**

*Wireless connection is used to connect to a PC. If a wireless connection has been set up, you can train with THERA-soft software. Further information can be found in the user manual.*



# EXPERT SECTION



*The expert section addresses trained suppliers, doctors and therapists and describes how to use the THERA-Trainer.*

## 13 CONTROL AND DISPLAY UNIT

All information in this chapter is more information for the therapist. Information on basic operation is contained in the user section (see Using control and display units).



### 13.1. Sub menu



Permanent changes are possible for some settings:

- Motor power
- Key sound setting (on/off)

Values will remain unchanged if the power supply is cut off.

Icon sub menu  shows that the sub menu is open.



To change factory settings:

- ▶ Press buttons  +  +  at the same time until the control and display unit shows sub menu.
- ▶ Set maximum motor power using the exercising resistance button.
  - Adjustment range: 2-8 Nm
  - Factory setting: 6 Nm
- ▶ Switch key sound on/off using the rotation direction button.
  - Key sound ON: loudspeaker displayed.
  - Key sound OFF: crossed-out loudspeaker displayed.
- ▶ Press START button to confirm all changed settings.
- ▶ Press STOP button to reject/cancel all changed settings and leave the sub menu.

### 13.2. Display operating hours



Do the following to display the operating hours:

- ▶ Press buttons  +  +  at the same time until the control and display unit shows operating hours.
- The screen displays a bar **1** for every 10,000 operating hours.
- The graphic indicates 10,030 operating hours.
- Display in hrs with the clock symbol.

Do the following to leave the operating hours display:

- Press any button.
- The display automatically disappears after approx. 30 seconds

### 13.3. Power limits



The control and display units displays error message E045 if power limits are not adhered to. The Thera-Trainer stops the training session.

#### Power exceeded

If the upper limit for power (60 Watt) is exceeded, the control and display unit displays "High + Watt".

- ▶ Make sure that the user does not exceed the upper power limit.

#### Number of rotations exceeded

If the upper limit for the number of rotations (95 rpm) is exceeded, the control and display unit displays "High + 1/min".

- ▶ Make sure that the user does not exceed the upper limit for number of rotations.

#### Power and number of rotations exceeded

If the upper limit for power (60 watt) and the number of rotations (95 rpm) is exceeded, the control and display unit displays "High + Watt + 1/min".

- ▶ Make sure that the user does not exceed the upper limit for power and number of rotations.

## 14. MOTOR POWER/PIN FORCE

### 14.1. Motor power



#### CAUTION!

##### Risk of injury due to inappropriate motor power.

- ▶ Check the configured motor power before every training session and adjust it to the user's fitness level.

The motor power

- is adjustable individually for every training and every user.
- limits the motor's maximum drive power.
- is adjustable between 2 and 8 Nm.
- Factory setting: 6 Nm

Setting the motor power to fit the user's individual needs:

- ▶ Limit motor power in sub menu (see chap. 13 Control and display unit).
- High motor power:
  - high exercising resistance
- Low motor power:
  - low exercising resistance
  - for sensitive joint systems

## 14.2. Pin force

The diagram below shows which pin forces act on the user after setting the motor power.



The pin forces acting on the user

- must be observed for every training session.
- increase with the motor power settings.

Pin forces  
in kg

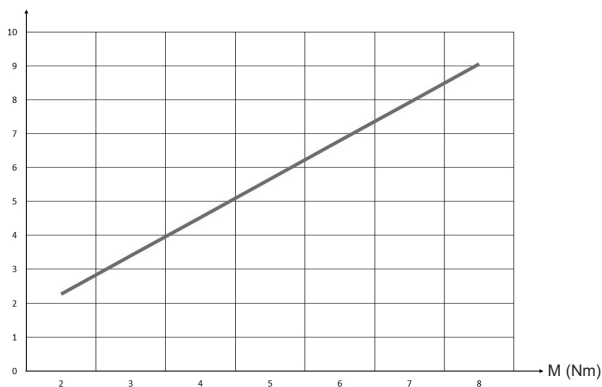

M = torque (power) of the motor

The manufacturer recommends the following before every training session:

- ▶ Consult therapist or doctor regarding the pin forces admissible for/acting on the user.
- ▶ Set motor power accordingly.

# TECHNICAL DATA

## 15. TECHNICAL DATA

THERA-Trainer	
Dimensions	l x w x h approx. 50 cm x 46-56 cm x 43 cm
Weight <input type="checkbox"/> with foot rests (leg exerciser) <input type="checkbox"/> with therapy grips (upper body exerciser)	approx. 13.2 kg approx. 12.1 kg
Mode of operation	Continuous operation
Crank length/radius	90 mm
Number of rotations range – passive training	0-60 rpm
Number of rotations range – active training	1-90 rpm
Torque range	approx. 2-8 Nm
Continuous power – active	50 watt (for approx. 120 minutes, at a room temperature of approx. 20 °C)
Nominal motor power	100 watt
Power input	30-46 VA
Power supply	100 - 240 V~, 50/60 Hz
Fuse	250 V T2.0 A HB
Medical device class	Ila
Protection class	II
Degree of protection	Type BF
Protection category	IP21
Sound emission	LpA < 70 dB(A)
Ambient conditions for use	5 °C to 40 °C 15 % to 93 % Rh 700 hPa to 1,060 hPa
Ambient conditions for transport/delivery	-25 °C to 70 °C 15 % to 93 % Rh 700 hPa to 1,060 hPa
Suitable for users with <input type="checkbox"/> Height <input type="checkbox"/> Body weight	120 cm to 200 cm up to 140 kg
Materials used	Steel, stainless steel, plastic (PA6, PA6 reinforced with glass fibre), rubber, aluminium
Operational life THERA-Trainer	7 years
Power consumption in stand-by mode <input type="checkbox"/> Control and display unit mobi 2.7" - wireless	approx. 2 watt
Software version	Control and display unit: <input type="checkbox"/> Software 02.00.x <input type="checkbox"/> User manual valid for software version indicated above or higher.
Dimensions control and display unit with 2.7" wireless	Diagonal: 6.8 cm Width: 5.4 cm Height: 4.0 cm



*The training parameters displayed are subject to specific tolerances. Service instructions may be requested from the manufacturer if required.*

## 16. CLEANING AND DISINFECTION

### **DANGER!**

#### **Risk of infection due to contaminated accessories/options!**

- ▶ Wear gloves during cleaning and disinfection.

### **WARNING!**

#### **Danger to life due to electric shock!**

- ▶ Prior to any cleaning or disinfection, unplug the power plug from the socket outlet.
- ▶ Make sure that no cleaning agent or disinfectant gets into the Thera-Trainer.
- ▶ If any cleaning agent or disinfectant gets into the Thera-Trainer, contact a trained supplier immediately.

### **NOTE!**

#### **Material damage due to incorrect cleaning or disinfection.**

- ▶ Use exclusively wipe disinfection.
- ▶ Never use cleaning agents that are aggressive, abrasive or caustic, or contain solvents.
- ▶ Use exclusively the following disinfectants:
  - liquid alcohol-based cleaning agents
  - disposable germ-killing wet wipes
- ▶ Use exclusively mild and environment-friendly cleaning agents and disinfectants.
- ▶ Use suitable cleaning agent (e.g. for TFT screens, etc.) for the screen.
- ▶ Use exclusively disinfectants that conform to country-specific regulations.
- ▶ Observe manufacturer safety instructions for cleaning agents and disinfectants.

The manufacturer recommends cleaning and disinfecting the Thera-Trainer as follows:

- ▶ Daily disinfection and cleaning of the Thera-Trainer:
  - Wipe foreign liquids (blood, urine etc.) with disposable germ-killing wet wipes, or wipe-disinfect the device using an alcohol-based disinfectant.
  - Remove coarse dirt with mild (non-abrasive and non-corrosive) household cleaning agents and a damp cloth.
- ▶ Use exclusively the following disinfectants:
  - Liquid alcohol-based cleaning agents
  - disposable germ-killing wet wipes



- ▶ Disinfecting and cleaning the THERA-Trainer before every new user:
  - Wipe foreign liquids (blood, urine etc.) with disposable germ-killing wet wipes, or wipe-disinfect the device using an alcohol-based disinfectant.
  - Wipe-disinfect all contact surfaces (control and display unit, therapy grips, foot rests) before and after every use, especially when the device is used by users with open sores or incontinence problems.
  - Alternatively it is also possible to protect the contact surfaces with sterile disposable bags or foils, which are to be changed after every use.
- ▶ Only use alcohol-based watery disinfectants (ascending order of efficiency: methanol < ethanol < isopropanol < n-propanol) for wipe disinfections.
- ▶ Clean/disinfect THERA-Trainer regularly according to infection control measures prescribed by the facility in question.
- ▶ Use disposable, germ-killing alcohol-based wet wipes for alternative disinfections.
- ▶ Observe instructions of the disinfectant manufacturer, as well as applicable legal provisions.

Clean/disinfect the THERA-Trainer as follows:

- ▶ Ensure that the room is adequately ventilated during cleaning and disinfection.
- ▶ Clean surface of the THERA-Trainer with a soft and damp cloth.
- ▶ Clean surface of the THERA-Trainer exclusively by wipe disinfection.
- ▶ Clean foils and stickers carefully.
- ▶ Soak velcros and wristbands for therapy grips in a watery alcohol-based disinfectant solution to disinfect.
- ▶ Allow disinfected parts to dry completely.
- ▶ Only use the THERA-Trainer again after contact time and drying time defined by disinfectant manufacturer is over.
- ▶ Clean feet of device before every training session.

Clean/disinfect wristbands for safety handles as follows:

- ▶ Wash Neoprene parts of wristbands for therapy grips in a washing machine at 30 °C with a mild detergent, but without softener.
- ▶ Do not tumble dry Neoprene parts.
- ▶ Stains can be removed by using ethanol.

## 17. MAINTENANCE AND REPAIRS

### **WARNING!**

#### **Danger to life due to electric shock!**

- ▶ Prior to any maintenance or repair work, unplug the power plug.

### 17.1. Maintenance

The THERA-Trainer is maintenance-free.



*The manufacturer recommends a technical inspection after 24 months.*

*If the housing of the THERA-Trainer is opened, a technical inspection is required. The corresponding information for the technical check is available from the manufacturer upon request.*

### 17.2. Further use

The THERA-Trainer is suitable for further use by a different customer.

Before each further use:

- ▶ Clean and disinfect the THERA-Trainer thoroughly (see chap. 16. Cleaning and disinfection).
- ▶ Ensure that the power plug, housing, foot rests and therapy grips are not damaged.
- ▶ Check if all accessories and options are complete (see delivery note).
- ▶ Replace velcros and velcro patches.



*Furthermore, the manufacturer recommends performing a technical check. The corresponding information for the technical check is available from the manufacturer upon request.*

### 17.3. Replacing the fuse

#### **NOTE!**

#### **Material damage due to incorrect fuse!**

- ▶ Use exclusively fuses recommended by the manufacturer (see chap. 15. Technical data).

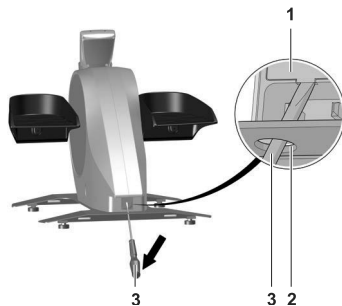

#### **Fuse type**

Fuse used:

- 1 x 250V T2.0 A HB

Replace fuse as follows:

- ▶ Pull power plug.
- ▶ Place THERA-Trainer upright and ensure it cannot fall or tip over.
- ▶ Enter screwdriver **3** through the service hole **2** from below and pull out fuse slot by the tip of the fuse holder **1**.
- ▶ Replace defective fuse with new fuse (see chap. 15. Technical data).
- ▶ Make sure that the fuse has been properly changed.
- ▶ Push fuse holder into fuse slot.
- ▶ Place THERA-Trainer horizontally on floor or table.

## 18. TROUBLESHOOTING

### 18.1. Control and display unit

*Up to error message E127, the control and display unit shows error messages for approx. 3 seconds. This is followed by an automatic restart.*



*From error message E128, the control and display unit shows error messages permanently. There is no automatic restart.*

- ▶ Observe troubleshooting instructions.

Error code	Troubleshooting
E007	Main controller board defective. <input type="checkbox"/> Contact trained supplier.
E009	Cabling faulty or defective. <input type="checkbox"/> Contact trained supplier.
E016	Cabling faulty or defective. <input type="checkbox"/> Contact trained supplier.
E017	Main controller board is incompatible with the THERA-Trainer. <input type="checkbox"/> Contact trained supplier. <input type="checkbox"/> Have main controller board replaced.
E035	<input type="checkbox"/> Pull out power plug and plug it back in after approx. 5 seconds. THERA-Trainer boots up.  If error message occurs repeatedly: <input type="checkbox"/> Contact trained supplier.
E036	<input type="checkbox"/> Pull out power plug and plug it back in after approx. 5 seconds. THERA-Trainer boots up.  If error message occurs repeatedly: <input type="checkbox"/> Contact trained supplier.
E038	Software versions incompatible. <input type="checkbox"/> Contact trained supplier. <input type="checkbox"/> Replace the main controller board and the control and display unit.
E039	<input type="checkbox"/> Pull out power plug and plug it back in after approx. 5 seconds. THERA-Trainer boots up.  If error message occurs repeatedly: <input type="checkbox"/> Contact trained supplier.
E040	Cabling faulty or defective. <input type="checkbox"/> Contact trained supplier. <input type="checkbox"/> If necessary replace the main controller board.

Error code	Troubleshooting
E041	Main controller board defective. <input type="checkbox"/> Contact trained supplier.
E044	Cabling faulty or defective. <input type="checkbox"/> Contact trained supplier. <input type="checkbox"/> Replace the main controller board and/or the control and display unit.
E045	The upper limits for the number of rotations/power are exceeded. The THERA-Trainer terminates the training session. <input type="checkbox"/> Reduce exercising resistance or number of rotations. <input type="checkbox"/> Make sure that the user does not exceed the upper limit for number of rotations (90 rpm) and power (60 watt).
E128	THERA-Trainer is overheated. <input type="checkbox"/> Switch off the THERA-Trainer. <input type="checkbox"/> Pull power plug. <input type="checkbox"/> Let the THERA-Trainer cool down for 60 minutes.  If error message occurs repeatedly: <input type="checkbox"/> Contact trained supplier.
E129	THERA-Trainer is overheated. <input type="checkbox"/> Switch off the THERA-Trainer. <input type="checkbox"/> Pull power plug. <input type="checkbox"/> Let the THERA-Trainer cool down for 60 minutes.  If error message occurs repeatedly: <input type="checkbox"/> Contact trained supplier.
E130	Control and display unit defective: <input type="checkbox"/> Contact trained supplier. <input type="checkbox"/> Replace control and display unit.
E131	Control and display unit defective: <input type="checkbox"/> Contact trained supplier. <input type="checkbox"/> Replace control and display unit.
E132	Control and display unit defective: <input type="checkbox"/> Contact trained supplier. <input type="checkbox"/> Replace control and display unit.
E133	Control and display unit defective: <input type="checkbox"/> Contact trained supplier. <input type="checkbox"/> Replace control and display unit.
E134	Control and display unit defective: <input type="checkbox"/> Contact trained supplier. <input type="checkbox"/> Replace control and display unit.

## 18.2. General errors

Error	Troubleshooting
The THERA-Trainer has too little power	<input type="checkbox"/> Increase motor power by one level.  Damage to tendons or joints due to overstraining is possible. <input type="checkbox"/> The manufacturer recommends consulting the doctor/therapist before you make any changes to the settings.

Error	Troubleshooting
Operating the THERA-Trainer is not possible	<ul style="list-style-type: none"> <li><input type="checkbox"/> Make sure that the THERA-Trainer is not in stand-by mode.</li> <li><input type="checkbox"/> Make sure that power supply cable is intact and correctly connected.</li> <li><input type="checkbox"/> Make sure that helix cable is intact and correctly connected.</li> <li><input type="checkbox"/> Check fuse.</li> <li><input type="checkbox"/> Pull out power plug and plug it back in after approx. 5 seconds.</li> </ul>
“STOP” appears on control and display unit.	<ul style="list-style-type: none"> <li><input type="checkbox"/> Press and hold EMERGENCY STOP button.</li> <li><input type="checkbox"/> To continue exercising see chap. 9.4. Safety equipment</li> </ul>
“bloc” appears on control and display unit.	<ul style="list-style-type: none"> <li><input type="checkbox"/> Foot rests or therapy grips are blocked.</li> <li><input type="checkbox"/> To continue exercising see chap. 9.4. Safety equipment</li> </ul>

## 19. DISPOSAL

To dispose of the THERA-Trainer:

- ▶ Observe country-specific regulations and specifications.
- ▶ Dispose of metal parts as scrap metal.
- ▶ Dispose of plastic parts according to the type of material.
- ▶ Dispose of electric and electronic components as electronic scrap.

## 20. NOTES ON ELECTROMAGNETIC COMPATIBILITY

### 20.1. Lines, line lengths and accessories

Operate the THERA-Trainer exclusively with the original mains supply cable.

### 20.2. Warning notice regarding installation

Do not use the THERA-Trainer in the immediate vicinity of other devices or stacked with other devices.

If there is no alternative to operation next to or stacked with other devices, observe THERA-Trainer to check if the arrangement permits it to work as intended.

### 20.3. Electromagnetic emission and immunity

- The device is classified according to CISPR 11 in Group 1 Class B; for immunity test levels it is designed according to DIN EN 60601-2:2016-05 (EN 60601-2:2015, IEC 60601-1-2:2014) for the environment as intended use of Table 4, 5 and 9.
- Deviations or simplifications regarding the above-mentioned immunity test levels are inadmissible.
- Maintenance activities to maintain basic safety and essential performance characteristics are not required within the expected service life of 7 years.

### 20.4. Receiving and transmitting HF energy

Sender information / receiver information

- Frequency band (ISM band): 2.400 GHz - 2.4835 GHz
- Useful frequency band: 2.402 GHz – 2.480 GHz
- Channel bandwidth: 40 channels each 2 MHz
- Modulation: GFSK (Gaussian Frequency Shift Keying)
- Effective Radiated Power (EIRP): -4 dBm

## 20.5. User Information acc. to FCC15.21

Changes or modifications not expressly approved by the party responsible for compliance could void the user's authority to operate the equipment.

## 20.6. Statement for Class B digital device acc. to FCC 15.105

### Note

*This equipment has been tested and found to comply with the limits for a Class B digital device, pursuant to part 15 of the FCC Rules. These limits are designed to provide reasonable protection against harmful interference in a residential installation. This equipment generates, uses and can radiate radio frequency energy and, if not installed and used in accordance with the instructions, may cause harmful interference to radio communications. However, there is no guarantee that interference will not occur in a particular installation. If this equipment does cause harmful interference to radio or television reception, which can be determined by turning the equipment off and on, the user is encouraged to try to correct the interference by one or more of the following measures:*

- Reorient or relocate the receiving antenna.*
- Increase the separation between the equipment and receiver.*
- Connect the equipment into an outlet on a circuit different from that to which the receiver is connected.*
- Consult the dealer or an experienced radio / TV technician for help.*

## 20.7. Statement acc. RSS Gen Issue 4, Sect. 8.4

### English

This device complies with Part 15 of the FCC Rules and with Industry Canada license-exempt RSS standard(s). Operation is subject to the following two conditions:

- this device may not cause harmful interference, and*
- his device must accept any interference received, including interference that may cause undesired operation.*

### French

Le présent appareil est conforme aux CNR d'Industrie Canada applicables aux appareils radio exempts de licence. L'exploitation est autorisée aux deux conditions suivantes:

- l'appareil ne doit pas produire de brouillage, et*
- l'utilisateur de l'appareil doit accepter tout brouillage radioélectrique subi, même si le brouillage est*
- susceptible d'en compromettre le fonctionnement.*

## 21. WARRANTY

In accordance with legal regulations, the manufacturer grants a manufacturer's warranty for the THERA-Trainer if it is handled with due care. The basis is the date of delivery.

Within this period of time, the manufacturer will replace free of charge any faulty parts of the THERA-Trainer or repair free of charge the THERA-Trainer in the factory or an authorised workshop.

The following is excluded from the manufacturer's warranty:

- Wear parts
- Opened devices
- Third-party installations and attachments
- Devices repaired by persons other than trained suppliers.
- Any damage due to incorrect use.
- Any damage caused by insufficient packaging.



MANUFACTURER:

## **THERA-Trainer®**

a trademark of  
medica Medizintechnik GmbH

Blumenweg 8  
88454 Hochdorf  
Germany

Tel: +49 7355-93 14-0  
Fax: +49 7355-93 14-15

Email: [info@thera-trainer.de](mailto:info@thera-trainer.de)  
Internet: [www.thera-trainer.de](http://www.thera-trainer.de)

*THERA-Trainer hereby declares that the wireless equipment type control and display unit mobi 2.7" wireless complies with Directive 2014/53/EU. The full text of the EU Declaration of Conformity and further declarations of conformity are available at the following Internet address: [www.thera-trainer.de](http://www.thera-trainer.de)*

Article no.: A004-667\_Rev 03  
Last update: CW12/2018



See [www.thera-trainer.de](http://www.thera-trainer.de) for declarations of conformity